

SIEMENS

Local Service Organization Service Manual

C35 Series



SIEMENS COMMUNICATIONS UNLIMITED

Table of Content

CHAPTER 1		Language Groups	32
Cellular Communication		Customer Specific Initialization	34
Coverage Concept	1	International Mobile Equipment Identity	34
GSM Network Architecture	2	Phone Unblocking	35
Subscriber Identity Module	3	CHAPTER 3	
SIM Application Toolkit	4	Siemens Service Equipment	
Extended GSM 900 - EGSM	5	Introduction	37
Built-in Modem	5	Other equipment	39
Data Application	6	Software Installation	40
		Configuring the test software	41
CHAPTER 2		Running the test sequence	42
Level 2 Service Guide		ANNEX A	46
Introduction	7	ANNEX B	49
C35 Series Technical Information	8	CHAPTER 4	
Accessories	10	Level 2.5 Repair Document	
General Information	11	Introduction	50
C35 Series Exploded Diagram	13	Antenna Connector	51
Mechanical Concept	14	Ringer	55
Hardware Concept – Block diagram	15	Bottom Connector (Lumberg)	58
Hardware Description	16	Display Connector	62
Power Supply Concept	18	Keyboard LED	66
Over voltage Condition	18	Display LED	69
Battery	19	Infrared Diodes	73
Short Circuit Protection	19	ANNEX C	
Charging	19	PC Adapter Cable & Accessories C35	76
Deep Discharge Battery	20	Power Plug for C35	77
C35 Spare Parts Level 2	21	Car installation Ratio Unit, C35	78
Disassemble the C35	22	Car Installation kit Handfree kit	79
Disassemble/Assemble Lower Housing	24	Car Installation kit Handfree Pro.	80
Disassemble/Assemble Control Board Assy	25	Car Installation Comfort GPS, C35	81
Disassemble/Assemble Upper Housing	27	References	83
Assemble the C35	28		
Mobile Software Programming	30		

Cellular Communication

Coverage Concept.

The cellular systems is made up of numerous transmitting and receiving sites, whose individual coverage areas partially overlap. The concept of frequency re-use, same frequency is used by several sites, allows a high traffic density in a wide area. Due to the limited transmission range of the terminals, cellular systems are based on a large number of base stations on the infrastructure side, scattered over the area to cover, with each covering a fairly small geographical zone called cell. Cells are often represented by hexagons (see figure 1.1.).

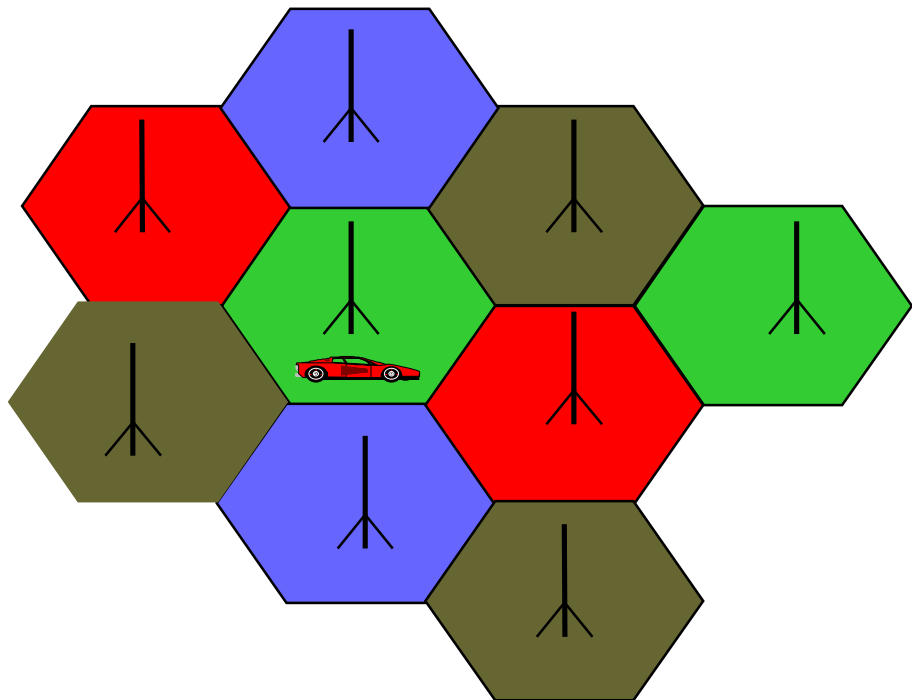

FIGURE 1.1 CELLULAR COVERAGE REPRESENTATION.

GSM Network Architecture.

GSM network can be broadly divided into three broad parts, namely:

1. Mobile Station(MS) carried by the subscriber,
2. Base Station Sub-system(BSS) which controls the radio link with the mobile station.
3. Mobile Switching Center(MSC) which performs the switching of calls between the mobile users, and between mobile and fixed network users.

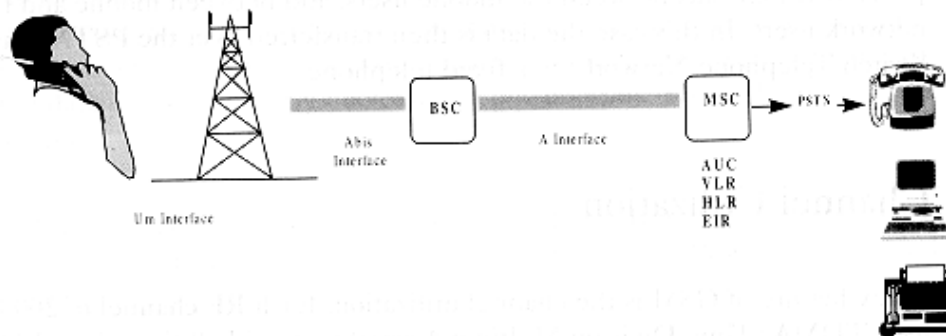

FIGURE 1.2 GSM ARCHITECTURE

Each mobile station is given a unique identity. As soon as the mobile phone is turned on, it registers with the network and is authenticated, as such the network could always find the mobile phone.

Larger amount of data is being exchanged to and from the following functional blocks in the MSC:

Visitor Location Register, VLR

Stores information about mobile subscribers that enter its coverage area which is associated with the geographical area where the mobile is currently roaming. When there is an incoming call for the mobile, the HLR is interrogated about the present address of the VLR.

Home Location Register, HLR

A database that contains all data concerning the subscription of the mobile subscriber, i.e. their access capabilities, subscribed services, and supplementary services. It also contains information about the VLR that is handling the mobile station currently. When the mobile changes location, the HLR is updated accordingly. It also provides the MSC with information about the MSC area where the mobile is actually located to allow incoming calls to be routed immediately to the called party.

Authentication Center, AUC

Stored information that is necessary to protect communication through the air interface against any intrusions. The legitimacy of the subscriber is established through authentication and ciphering, which protects the user information against unwanted disclosure.

Equipment Identity Register, EIR

An option the network operator can use to enforce security. With this feature the network can identify defective or stolen mobile that may not be used in the network.

Subscriber Identity Module(SIM)

SIM is a smart card which has a computer and memory chip that is permanently installed in the mobile equipment. It comes in either the size of a credit card or smaller version known as the plug-in SIM.



SIM card using 5V technology is not supported.

The subscriber information, which includes a unique number called the International Mobile Subscriber Identity (IMSI) is stored in the SIM card. SIM card identifies the subscriber to the network.

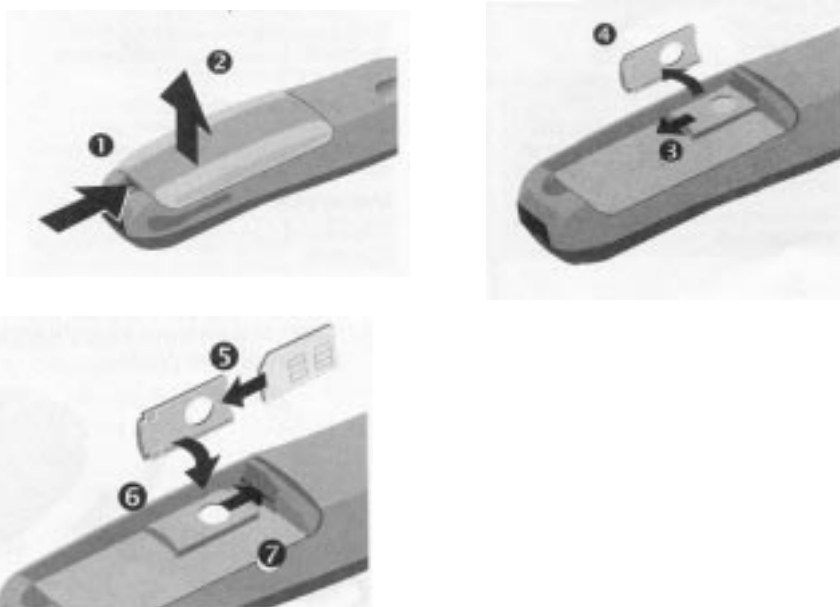

FIGURE 1.3 INSERT SIM CARD

Figure 1.3 illustrates the steps for inserting the SIM card into the C35 series.

To protect the SIM card from improper use, a security feature, a four digits personal identification number (PIN), is built in. The PIN is stored in the card and can be changed by the subscriber. PIN2 is required for additional funtions available with a special SIM card (Consult the operator for more information about the PIN).

A code (PUK) is provided for unlocking the SIM card if the SIM card is blocked



To deactivated SIM locked, due to wrong PIN entry,
Get the unblock code from the operator.

Change PIN Procedures.

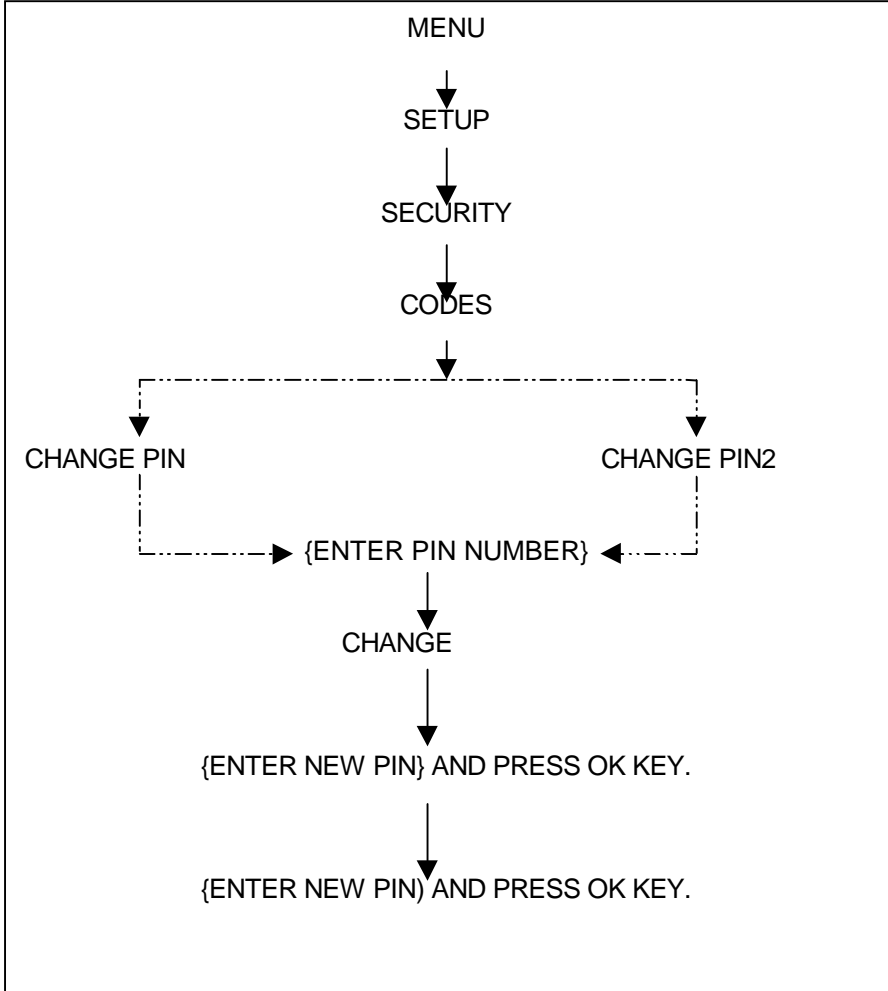

CHART 1.1 PIN CONTROL

SIM Application Toolkit

SIM Applications Toolkit (SAT) allows the flexibility to update the SIM, to change the services and download new services over the air. In the SAT specification, the short message service is a

key mechanism for personalizing the SIM in each user's GSM phone. It is designed as a client-server application. C35 series supports SAT Class 3 specification.

When active, the name of the service may appear in the menu, and there will be sub-menu if more than one application is active. Figure 1.6 is the SAT icon.



FIGURE 1.4 SAT ICON

Extended GSM 900, E-GSM

This is a new standard that allows Network Operators to increase their capacity through an extended frequency. The frequency range of E-GSM is as follows:

- Mobile Transmit: 880 – 915 MHz
- Mobile Receive: 925 – 960 MHz

C35 series is a GSM Phase 2 / Phase 2+ Dualband E-GSM / GSM 1800 mobile phone.

Built-in Modem.

C35i has an integrated modem for direct data communication using the data cable as shown in Figure 1.5. C35 do not have the built-in soft modem for Data Service of GSM network.



FIGURE 1.5 DATA CABLE.

Data Application Support

Modem driver conforms to V.25 command set, and transmission speed conforms ITU-T-standard of V.22bis. (2400, 4800,and 9600 bits/sec).

Facsimile conforms to Service Class 1, group 3 and operate at 2400, 4800, 7200 and 9600 bit/s.

Data services via GSM network up to 9600 bps, and remote control using cellular AT commands for C35i only.

Internet access via the C35i is possible with the inclusion of Wireless Application Protocol (WAP) browser 1.1 .

Chapter 2

Level 2 Service Guide

Introduction

The chapter is intended to help you carry out repair up to Level 2 on the C35 series mobile phone.

The repair for international version and Asian variants are identical unless otherwise noted, therefore the description herein is confined to C35 only.



All repairs have to be carried out in an environment set up according to ESD regulations defined in international standards.

ESD procedure is available from your Service Manager. Ask for ASC/T001/98

C35 & C35i Technical Information

System	GSM Phase 2/Phase2+, Dual Band EGSM 900, Class 4(2 Watt) GSM 1800, Class 1(1 Watt)
Operating Voltage	3.6V
Size(LxWxH)	118 x 46 x 21 mm(without antenna)
Volume	88cm ³ including battery (approx)
Weight	116g including battery (approx)
Battery(Standard)	NiMH, 500mAH(Standard) Li-Ion, 600mAH(Optional)
Standby time ¹	50 to 180 hours (standard battery)
Talk time ¹	90 to 300 minutes (standard battery)
Charging Time	Up to 1.5 hours with Rapid Charger
SIM support	Plug in card 1.8 V or 3V
Antenna	Non - retractable, $\lambda/2$, helical fixed.
Speech codec	Triple rate <i>Enhance Full Rate</i> <i>Full Rate</i> <i>Half Rate</i>
Display	101 x 54 pixel graphical display with up to 5 lines 12 x 12 font size for Chinese
Keypad	12 numeric keys(10 numeric, #, *) 4 function keys(Send, End-ON/OFF, Menu, Phonebook) 2 multifunctional softkeys
Key Sound	Click/DTMF/None
Key Lock	Activation and Deactivation by #-key or Automatic.

¹ Actual time dependent on the network.

Dialing	10 redial numbers, Last 10 incoming with date/time stamp Last 10 outgoing calls Last 10 missed calls with date/time stamp
Ringer	On/Beep/Off Up to 22 melodies and 5 ringing volume settings (Melody Composer, Crescendo Ringing)
Volume	Adjustable in 4 levels during call via softkey
Silent Alert	Built-in vibrator
Phone Book	Storage depends on the SIM card capacity Storage of up to 100 list in the phone (VIP)
SMS Support	MT, MO, CB Predictive Text Input, Tegic T9.
Supplementary Services	Call Forwarding, Call Hold, Call Wait, Multiparty Conference, CLIP, CLIR, AoCC AoCI, FDN, LND USSD and SAT.
Ciphering	A5/1 and A5/2 supported
PIN control	PIN 1 & 2 Code Control
Phone code	4 to 8 digit code
Network function	Automatic and manual network selection
Chipset	Siemens E – GOLD
WAP Browser ¹	Version 1.1
Other Features	Clock / Alarm Alarm List ² Built-in modem ³ Calculator ⁴ Currency Converter 4 Games 7 User Profiles

¹ Only for Model C35i.

² Not available in C35 International version.

³ Not available in C35 International version.

⁴ Not available in C35 International version.

Accessories:

1. Standard Battery	L36880-N4001-A100
2. Optional Battery	L36880-N4001-A101
3. Standard Charger	L36280-Z4- <u>CXXX</u> (Country Variant)
4. Travel Charger	L36880-N4001-A103 (EU) / A104 (UK) Similar to standard charger with an universal input voltage from 90 ~ 240V
4. Desk Top Charger	L36880-N4001-A102
5. Belt Clip	L36880-N4001-A113
6. Headset	L36880-N4001-A123
7. Antenna Cradle	L36880-N4001-A110
8. Car Charger Cable	L36880-N4001-A108
9. Car Kit Portable ¹	L36880-N3015-A117
10. Car Kit Comfort	L36880-N4001-A111
11. Car Handset ²	L36880-N3015-A123
12. Designer Cases	L36880-N4001-A119
13. Soft Data Link 3.0	L36880-N4001-A122 (Not for 3508i)
14. Data Cable ³	L36880-N3101-A102
15. Car Kit Professional Voice	L36880-N4001-A124
16. Data Cable Professional ⁴	L36880-N3101-A112

¹ Same as C25(88)

² Same as C25(88)

³ Same as C25(88)

⁴ Same as C25(88)

General Information

Due to different requirements of the markets, the C35 series has different variants, which broadly classified under International version and Asian version. Marketing name for international version is C35 or C35i, whereas Asian version is named 3508 or 3508i.

The 3508 series is equipped with a graphic display which enable the telephone to display CHINESE characters, either in Traditional font or Simplified font, beside the standard English.

Difference between C35(08) and C35(08)i

C35(08)i mobile software has WAP Browser 1.1 incorporated thus enabling user to surf the Internet and it have built-in soft modem for GSM Data Service.

The differences between the C35 and C35i are the hardware and software. The memory size of C35 is 16MB and that of C35I is 32MB.

There are also two variants for 3508, one without the WAP browser is 3508 and that with WAP browser version 1.1 is 3508i. The different for ASIAN version is only mobile software.

Wireless Application Protocol, WAP.

Wireless Application Protocol takes a client-server approach that uses the in-built micro-browser to make a request, in wireless markup language (WML), for information or service. The request is passed to a WAP Gateway which then retrieves the information from a Internet server, in HTML format, and translate it into WML. The requested information is then sent to from the WAP Gateway to WAP client (mobile) using the available and most appropriate mobile network bearer services.

Wireless Protocol Stack.

Wireless Application Environment (WAE)
Wireless Session Protocol (WSP)
Wireless Transaction Protocol (WTP)
Wireless Transport Layer Security (WTLS)
Wireless Datagram Protocol (WDP)
Bearers e.g. Data, SMS, USSD

TABLE 1..1 WAP PROTOCOL STACK

1. Wireless Application Environment

Defines the user interface on the phone. WAE contains the WML,WML script and the wireless telephony application (WTA).

2. Wireless Session Protocol

Link the WAE to two session services – one connection oriented operating above the WTP and a connectionless service operating above WDP.

3. Wireless Transaction Protocol

Runs on top of the datagram service and part of the standard suite of TCP/IP protocols, to provide a simplified protocol suitable for low bandwidth mobile station.

4. Wireless Transport Layer Security

WTLS incorporates security features that are based upon the established Transport layer Security (TLS) protocol standard, that include data integrity checks, privacy on the WAP Gateway to client leg and authentication.

5. Wireless Datagram Protocol

Allows WAP to be bearer independent by adapting the transport layer of the under-laying bearer. WDP presents a consistent data format to the higher layer on the WAP stack.

C35 Series Mechanical Diagram

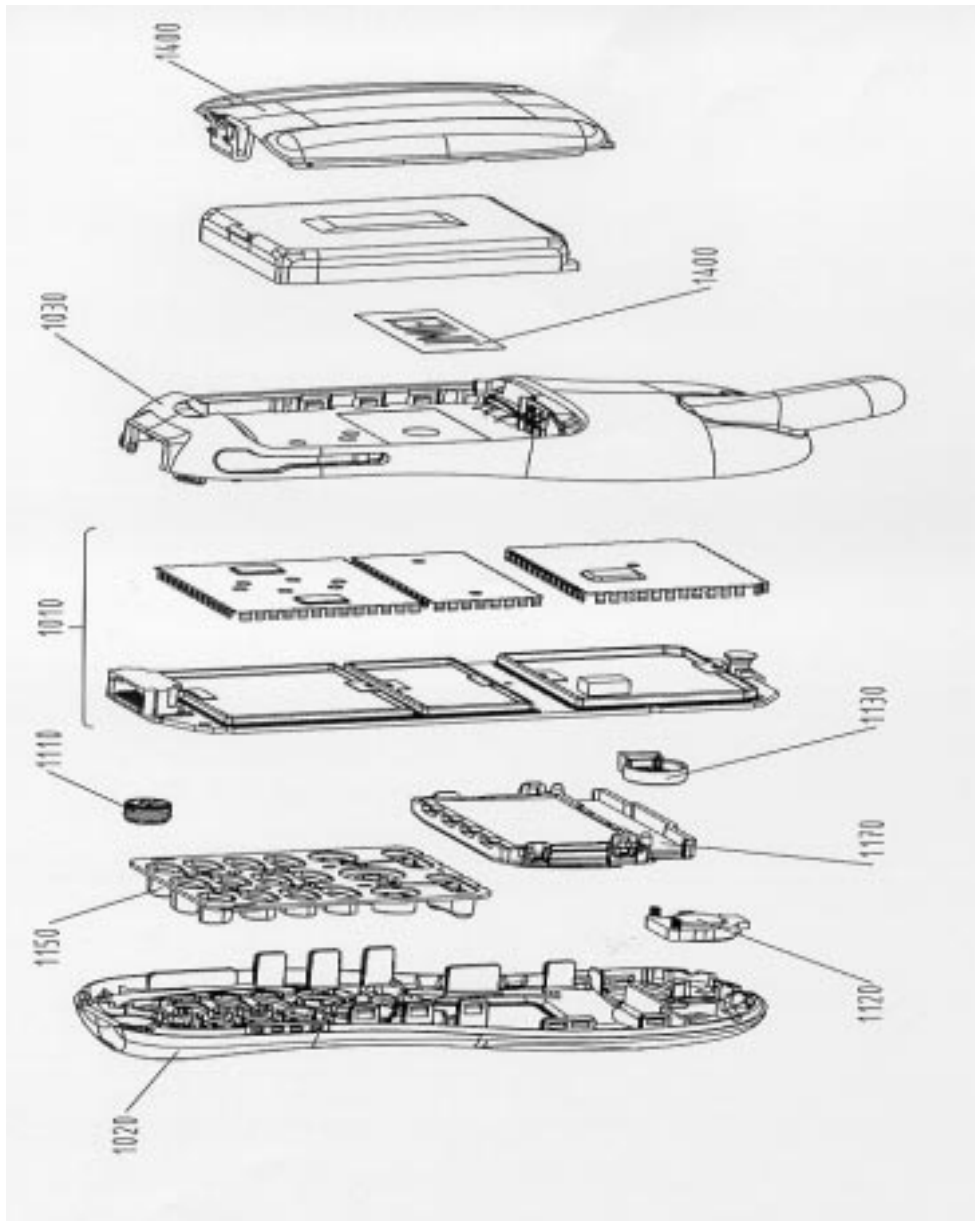

FIGURE 2.1 C35 MECHANICAL DIAGRAM.



Please take note that the number(s) used here IS NOT the part number, DO NOT used it in your spare parts purchase order.

Always refer to the SERVICE PART PRICE LIST for your spare part order.

Mechanical Concept

Note: All numbers refer to mechanical drawing in Figure 2.1.

The mechanical concept of the C35 differs in various points from the one of the other Siemens mobile telephones.

The first thing you will experience is how the housing is locked. In C35 no screws are used to keep the housing closed. Also inside the telephone no screws are used anymore. To open the housing, which is kept closed by catches only, a special opening tool has been defined. *For details on disassembly tool please refer to Photo 2.3 in this chapter.*

Inside, the C35 consists of just one board (1010) which carries display module(1170), control part and RF section of the mobile.

The display module (1170) is connected to the board by a flexible cable which is inserted into a plug. In case the display is defective electrically or mechanically it can be exchanged very easily.

C35 does have an external connector of a new type. Since S6 a so called "Molex"-connector was used, which also offered the possibility to connect an external antenna to it. The new "Lumberg"-connector which is used in C35 does not feature such a connection, because the connector for external antenna is located at the back side of the upper end of the mobile, close to the internal antenna (1130). As a consequence of this there is no need anymore for a RF cable mounted to the board nor for a RF plug on it to connect this cable. This improves RF-properties of the mobile and lowers production costs.

To be able to do measurements on and software update of the telephone, an adapter cable between Molex and Lumberg connector will be available. *See photos in Additional Tools of Chapter 3.*

C35 series antenna is of a snap-in type which inserted into the lower case shell (1030). The antenna can only be changed by opening up the C35 phone.



The C35 is a dual-band mobile operating on GSM900 and GSM1800, the antenna is an integral part of the lower housing.

The keypad (1150), the microphone (1110) and the loudspeaker (1120) are mounted into the upper case shell (1020). Make sure that the microphone and the earphone contact springs are not dirty or damaged during repair process.

The dust protection frame and the display window are included in the display module(1170).

Hardware Concept – Block Diagram

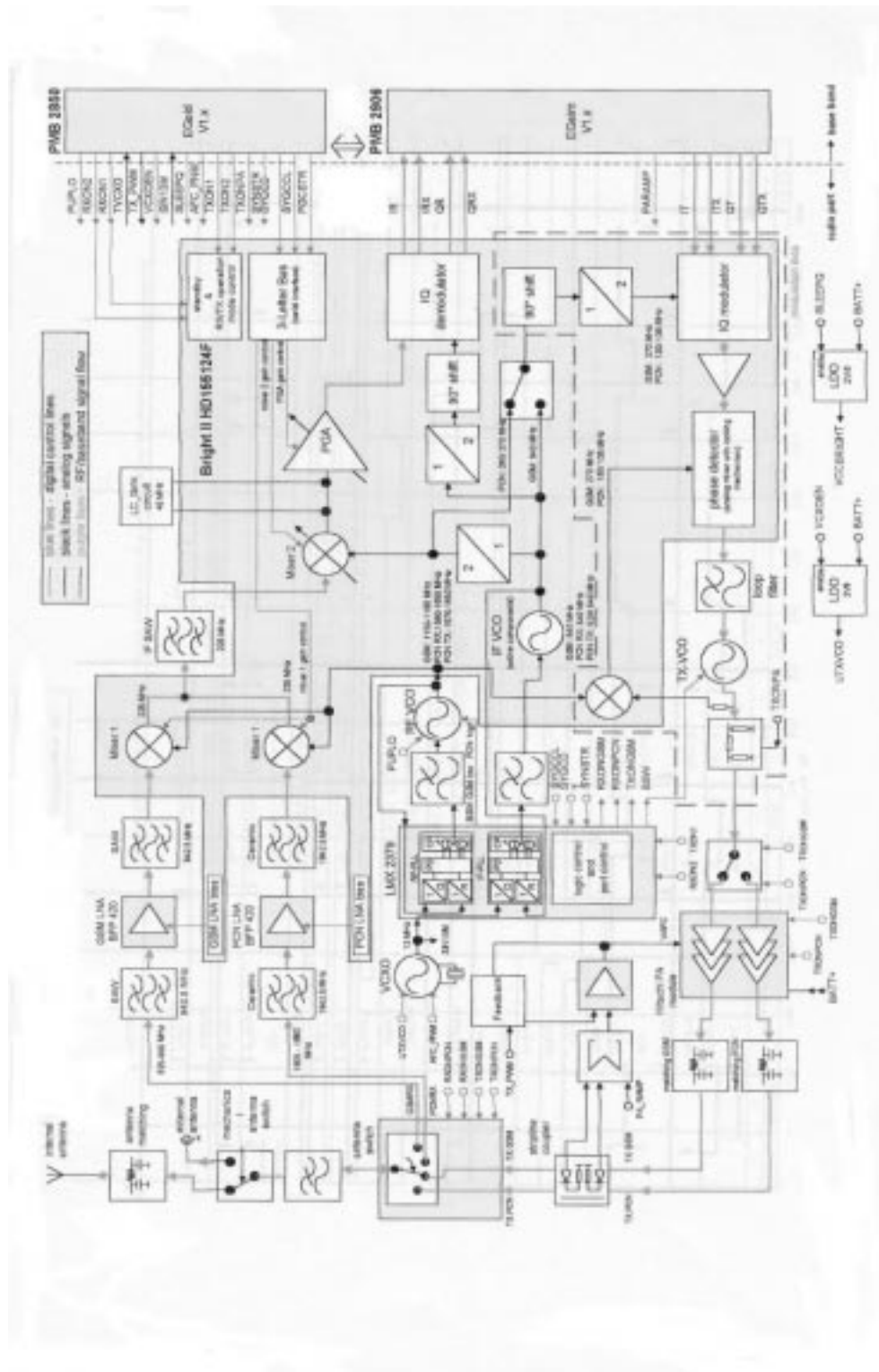

FIGURE 2.2 C35 BLOCK DIAGRAM.

Hardware Description

The handset consists of the following major integrated circuits:

1) **E-GOLD – PMB2851E**

This IC is a combination of microprocessor, signal processor and real-time clock.

The microprocessor part of this component is responsible for controlling the keyboard, SIM-Card, Flash and RAM. Furthermore it controls the power saving, power up/power down of the RF module and sets the amplification of the PA.

The signal processor part of PMB 2851E is responsible for processing the Rx I/Q signals (filtering, equalizing, speech and channel decoding).

Furthermore it does the speech and channel encoding and the GSMK modulation of the Tx I/Q signals. The Voice CODEC part is used to realize advanced features regarding coding of the speech signal. These are:

- Halfrate-Encoding
- Halfrate-Decoding
- Enhanced Fullrate Encoding
- Enhanced Fullrate Decoding
- Voice Activity Detection
- Comfort Noise

2) **GAIM – PMB2906**

The GAIM (GAIM = **GSM Analog Interfacing Module**) provides the interface between the analogue and its digital representation signals (Base-band I/Q, Voice-band, PA-control, Voltage & Temperature Measurement - Charging control).

3) **13Mhz Ref Oscillator Circuit -**

This circuit provides the following main functions:

- Generate 13Mhz clock signal for Logic Circuits – SIN13M.
- Generate 13Mhz reference signal for the PLL circuits for the Tx & Rx of GSM RF signal.
- Received the frequency steering control AFC_PNM from the HiGOLD IC for fine tuning of the Tx & Rx frequency.
- Temperature dependent resistor sited near the 13MHz oscillator measure the environment temperature.

4) Power Supply ASIC – D0767BA

This circuit provides the following main functions:

- Control of switch on of the Mobile phone by ON/OFF button, Ext Power (Charger) or real time clock.
- Watchdog monitor – switch off the mobile phone if no proper Watchdog signal send from HiGOLD IC.
- Voltage supply to the logic circuits – 2.90V, 2.65V & 1.92V, Simcard & real time clock in HiGOLD IC.
- Switch on the linear regulator to supply the 2.8V for the 13Mhz Oscillator circuit.
- RESET signal for the logic circuit.
- Charge control signal for switching the charge FET.
- Low battery detector.
- Over voltage protection.

5) Receiver Circuit – Bright II HD155124F

This circuit provides the following main functions:

- Low Noise Amplifier (LNA) with a fixed amplification of +20dB to amplify the input RF signal.
- Mixer to mix down the RF signal to the Intermediate Frequency (IF)
- Programmable IF amplifier with a dynamic range of 60dB (-10dB ~+50dB in steps of 2dB).
- Mixer to mix down the IF signal to the baseband, generating and inphase (I) and a quadrature (Q) signal and feed the GAIM IC base-band signal, RX I/Q for the decoding of the digital signal for the HiGOLD IC.

6) Transmitter Circuit – Bright II HD155124F

The GAIM IC generate the MOD I/Q base-band signal under the control of the HiGOLD IC and feed the IQ modulator of the Bright II IC. The Bright II IC provides the IF synthesizer, the I/Q modulator, prescaler to regulate the dual-band TX-VCO and feed the modulated GSM signal to the PA.



The telephone support only 1.8V and 3V SIM card
For user with 5V SIM card, he need to upgrade the SIM card
through his service provider/network operator

Power Supply Concept

The C35 has two main power inputs:

1. Battery voltage(3.6V) connected at the battery contact
2. Charging voltage(6.5V) delivered by the different charger type(see Accessory List) via the Lumberg connector at the bottom of the telephone.

Since the battery voltage is supplying the power supply ASIC, it is always needed to operate the phone. **You cannot switch on the handset if the battery voltage is not present.**

From the battery voltage, all other supply voltages are derived and controlled by the power supply ASIC.

The RF power amplifier is directly connect to the battery, a bad battery with high internal resistance can cause malfunction of the C35 phone.

The Logic module uses 1.92V, 2.65V & 2.9V generated by voltage regulators inside the ASIC.

Furthermore, the ASIC generates the supply voltage for the SIM card and the RESET signal for the logic devices.

The ASIC also checks the presence of the watchdog signal from the microprocessor and provides the switching on functionality (ON_OFF button or Ignition signal).



Wrong polarity or battery voltage setting that exceed the +6.5V could damage the phone.

Over-voltage Condition

- Battery voltage

If the supply voltage rises above 6.2V, the phone will switch off and it cannot be switched on again before the voltage is lower than 6.2V.

If the supply voltage rises above 7V, the phone can be damaged

- Charging Current



The charging current must not rise above 1A or a track fuse in the phone will blow. As a result charging the battery will no longer be possible.

Be careful with NON-original SIEMENS accessories or chargers. Make sure that the charging current is limited to value below 1A.

Battery

C35 series uses a Nickel Metal Hyride (NiMH) 500mAH battery pack as standard battery. It also support the Lithium Ion 600mAH battery pack (For S35i phone) as optional battery for customer want longer talk time.

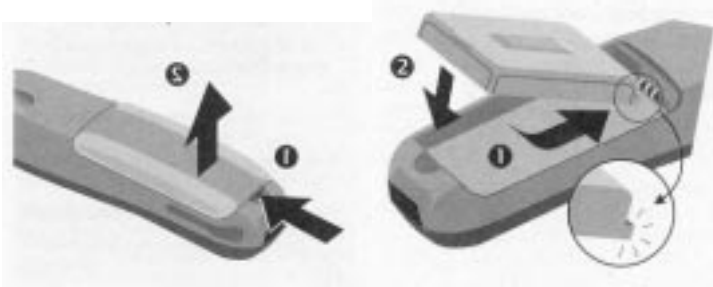

PHOTO 2.32 C35 SERIES INSERTING BATTERY.

For C35, BATT+ has a voltage level from +3.0V to 5.5V, and a BATT_TEMP contact is used for detecting abnormal increase in temperature of the battery.



If the temperature is too high or too low, there is a high probability that the battery is not charged. To enable the charging process again, battery and phone needs to cools down or warm up. Battery replacement is not required.

Avoid shorting the battery terminals.

Short Circuit Protection

For the Nickel Metal Hydrde battery, a polyswitch in the battery pack protecting the battery from short circuit and it should reset by itself after some time removing the short circuit.

For the Lithium Ion battery, it is short-circuit protected by an electronics fuse. The fuse will be activated in case a too high current is drawn. This fuse will **not reset** automatically.

The resetting of the L-ion battery fuse can be done with either of the following procedures:

1. Insert the battery into the C35 and then connect the rapid charger to the phone. Wait for approximately 10 second, then the mobile can be turned on again.
2. Plug the battery separately into the desktop charger. The fuse is reset immediately.
3. Insert the battery into the C35 and put the phone into the desktop charger. Wait for approximately 10 second, then the mobile can be switched on.

Charging

The battery can be charged when it is inserted into the phone. The charging process is completely controlled by the mobile. Charging can be done with any of the following accessory:

1. Rapid charger
2. Travel charger
3. Car charger
4. Desktop charger

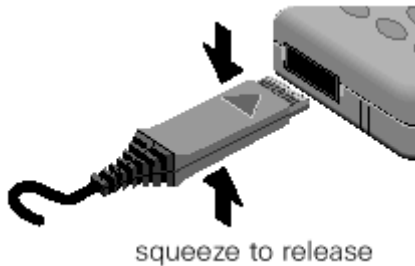

PHOTO 2.33 INSERT CHARGER

Photo 2.33 shows the correct way of inserting and removing the charger plug.

Deep Discharge Battery

In case of a deeply discharged battery, the voltage of the battery is too low to operate the charging circuit and the display controller, the phone can not be turned on and the normal charging process can not be started. No charging symbol is visible in the display.

In this case, charging the battery is divided into two different steps, which have to be run subsequently:

a) Trickle charge for C35 Phone

Trickle charge mode is automatically started if the battery voltage is below 3.0V when the charger is connected to the mobile. The charging current in Trickle mode is appr. 10mA.

Trickle charge mode has to last minimum until the battery voltage has exceeded 3.2V, then the phone will switch on and the charging icon appear. During trickle charge the charging symbol will not be visible and the telephone can not be turned on. This is because the battery voltage is too low to operate the telephone.

Action:

Insert battery into handset and connect travel charger to the telephone. If within 4 hours the battery voltage is high enough again, the charging symbol will come up.

If the battery is discharged very deeply, the symbol may not come up and the trickle charge time possibly has to be extended up to 24 hours.

b) Normal charge

When the battery voltage is above the a.m. value (e.g. by trickle charge) the mobile will start the normal charging mode and show a charging symbol in the display. * Always normal charge a new battery or a deep discharged battery for more then 12 hours before first use.

Action:

Connect charger to the telephone (*see section on Charging*).

The charging symbol will come up as an indication that the normal charging process has been started by the mobile.

Mobile Phone C35 Spare Parts Level 2

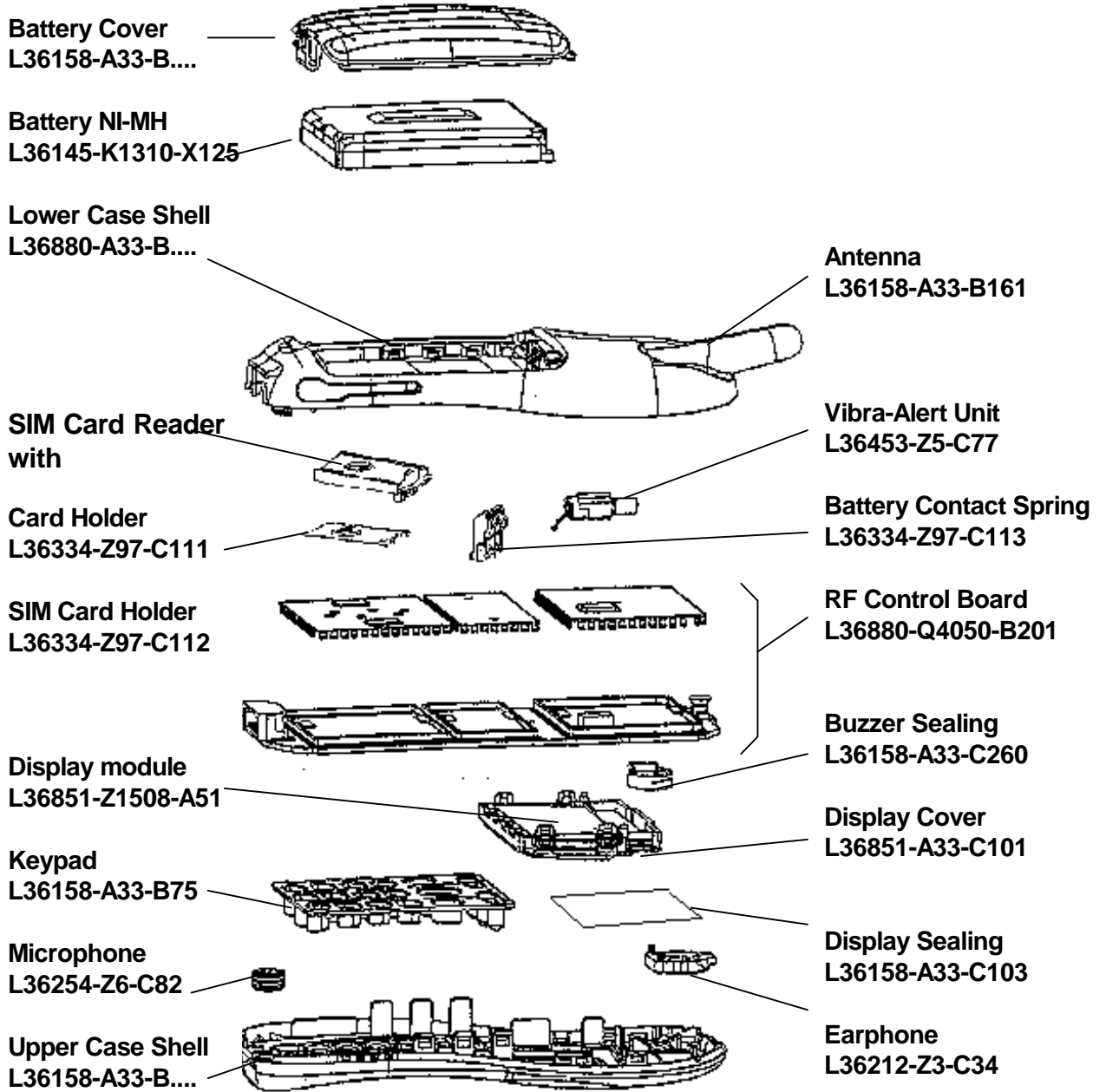

Disassemble the C35

A case opener is needed to disengage the latch of the C35 casing.



PHOTO 2.3 C35 CASE OPENER



*The part number for this mandatory tool is **F30032-P46-A1***

Refer to ANNEX B of Chapter 3 for Service Equipment List.

STEP 1:

Remove the battery cover then the battery as shown in PHOTO 2.4

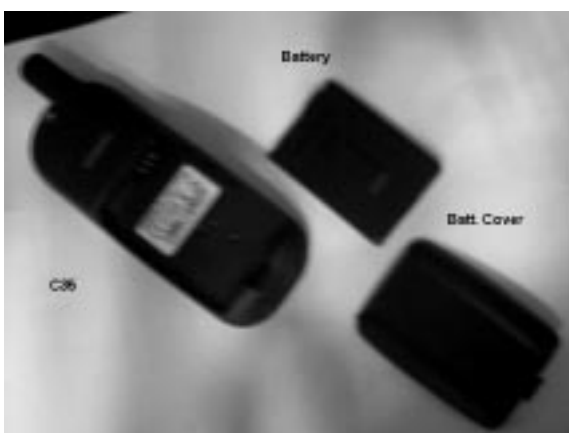

PHOTO 2.4 DISASSEMBLE C35 – STEP 1

STEP 2:

Open the housing with the opening tool and carefully pull the lower housing section off as illustrated in PHOTO 2.5



PHOTO 2.5 DISASSEMBLE C35 – STEP 4

STEP 3:

Use the Case Opener carefully disengaged the catches of the Lower housing and Upper housing to separate the housing and the Control Board Assembly as in PHOTO 2.6



PHOTO 2.6 DISASSEMBLE C35 – STEP 3

Disassemble/Assemble of the Lower Housing Assembly

STEP 1:

Open the housing with the opening tool and carefully pull the lower housing section off as illustrated in PHOTO 2.7



PHOTO 2.7 Lower Housing Assy – STEP 1

STEP 2:

Remove in sequence by hand the SIM Card Holder, SIM Card Reader, Battery Contact Spring, Vibra-Alert Unit and the Antenna as illustrated in PHOTO 2.8

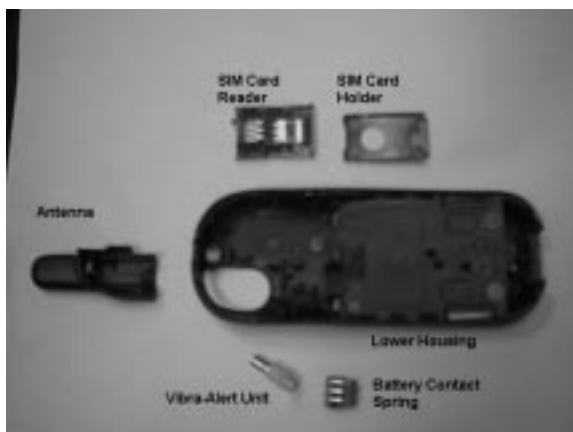

PHOTO 2.8 Disassembly Lower Housing – STEP 2

For Remove/Install the Antenna, watch out for the two catches on the Lower Housing. For install of the other parts, watch out for the guide notches. For the assembly of the Lower Housing just reverse the sequence for the disassembly.

Disassemble/Assemble the Control Board Assembly

STEP 1:

Open the housing with the opening tool and carefully pull the lower housing section off as illustrated in PHOTO 2.9



PHOTO 2.9 Control Board Assy – STEP 1

STEP 2:

Unlock the catches of the Display Module from the Control Board and move the display module to the lower part of the PCB. Lift up carefully the retaining clip of the display connector on the Control Board as illustrated in PHOTO 2.10

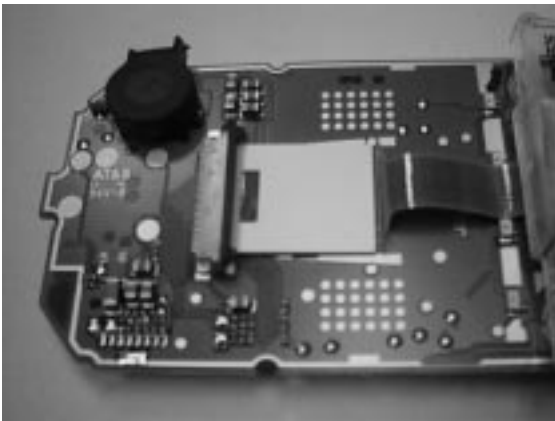

PHOTO 2.10 Disassemble Control Board Assy – STEP 2

STEP 3:

Remove the Display Module and the Buzzer Sealing from the Control Board as illustrated in PHOTO 2.11

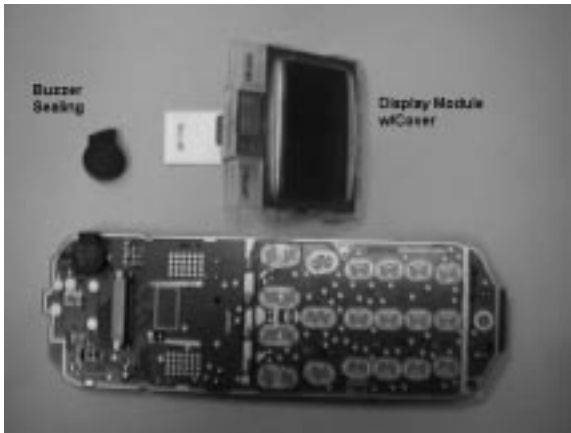

PHOTO 2.11 Disassemble Control Board Assy – STEP 2

For Remove/Install the display module, watch out for the catches on the display module and the guide hole of the PCB. For the assembly of the Control Board assembly just reverse the sequence for the disassembly.

Disassemble/Assemble of the Upper Housing Assembly

STEP 1:

Open the housing with the opening tool and carefully pull the lower housing section off as illustrated in PHOTO 2.12



PHOTO 2.12 Upper Housing Assy – STEP 1

STEP 2:

Remove the Keypad by hand and use a fine point metal tweezers to remove the microphone as illustrated in PHOTO 2.13



PHOTO 2.13 Disassemble Upper Housing – STEP 2



The loudspeaker is glued to the upper housing section by a foam covered with glue on both sides. When you remove it, the foam will be damaged. Please use new loudspeaker for assembling Upper Housing Assembly.

For assembly of a new Upper Housing install a new earphone first, watch out for the orientation. For install of the other parts just reverse the sequence for the disassembly.

Assemble the C35

STEP 1:

Check that the Lower Housing Assembly, Control Board Assembly and Upper Housing Assembly are in good order. Check if the Buzzer sealing was installed on the Control Board.



New Upper and Lower Casing must be used. All contact pins must not be dirty, damaged or bent!

If any part is not O.K please replace it with a new part.



STEP 2:

Place the Control Board Assembly in the Lower Housing Assembly and then place the keypad on top of the Control Board as illustrated in PHOTO 2.15. You may insert a battery in this step to test that the phone can be switched on.



PHOTO 2.15 ASSEMBLE C35 – STEP 2

STEP 3:

Close the device by putting on the Upper casing section as illustrated in PHOTO 2.16. Hold the phone and use both hands to close the casing starting from the catches at the top part near the antenna, watch out for leaving any finger marking on the display screen.



Do not place the phone on the table to close up the housing as the Antenna may be damage.

ALL CATCHES MUST ENGAGE COMPLETELY!



PHOTO 2.16 ASSEMBLE C35 – STEP 3

STEP 4:

Remove old IMEI label from the old housing using a hair-dryer for re-use of the IMEI label or paste the new IMEI label supplied for control board replacement. Insert the battery and put back the battery cover. Ready for testing.



PHOTO 2.17 ASSEMBLE C35 – STEP 4

Mobile Software Programming

Model before C25 and C35, software used for the mobile are similar except for their differences in the language group. Customer specific values (e.g. ringing tones etc) are seldom, but there were some, were included in the common mobile software.

C25 and C35 has changed. There is still a common mobile software available which is divided into language groups. However, this software does not contain the specific settings, such as ringing tones, greeting text, short dial list etc., required by the operator(s) or service provider(s). Therefore, it is not uncommon to have some menu item(s) differ in different variants or are not visible at all. These settings are stored in different memory area of the mobile and will be activated depending on the customer specific model or variant of the phone by a separate test step during the production process.

Due to this separation of common mobile software and customer specific initialization, it is possible to fulfill the demands of the market requiring customization and flexibility.

As a consequence the software programming process in the LSO is divided into two different steps as followed:

1. Software update to actual version and appropriate language group
2. Programming of CUSTOMER SPECIFIC INITIALIZATION

Mobile Software Updating

The software of the mobile, C35 series, is loaded from a PC directly. Hardware interconnection between the mobile and the PC is shown in Figure 2.6

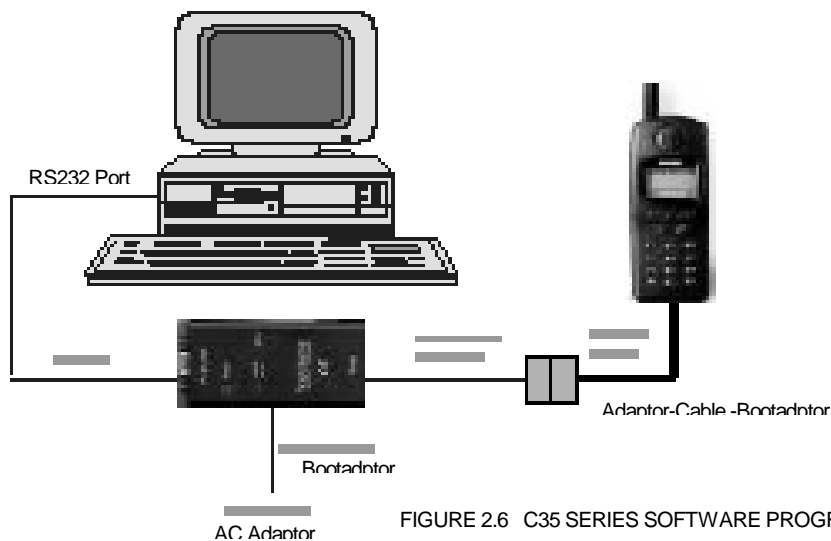

Because of the new type of external connector used in C35 (Lumberg type) an additional adaptor cable between mobile and boot adaptor is required. Table 2.1 listed all the hardware requirements

If you use the C35 battery dummy, then make sure that the power supply voltage is correctly adjusted 4.0V & 3A current rating.

Description	Part No.
Adaptor-Cable-Bootadaptor, C35/C35	V30146-A5004-D
Boot Adaptor	L24857-F1006-A30
IBM Compatible PC – Pentium	-

TABLE 2.1 EQUIPMENT LIST FOR SOFTWARE PROGRAMMING.



SOFTWARE IS A DOS-BASED PROGRAM, IT IS ADVISABLE TO DO THE SOFTWARE UPGRADE IN DOS ENVIRONMENT.

Language Groups

There are over 20 languages for the C35i series in total. These languages are divided into groups as follows

C35i / 3508i	
Group	Languages
1	English, German, French, Italian, Dutch , Swedish, Finnish, Norwegian, Danish.
2	English , German, French, Italian, Dutch, Swedish, Finnish, Norwegian, Danish.
3	English , German, French, Italian, Spanish , Catalan, Portugese , Dutch.
4	English, German , Hungarian, Polish, Russian, Bulgarian, Czech, Slovakian.
5	English, French, Italian , Arabic, Greek, Turkish, Hebrew, Bahasan Malaysia, Bahasan Indonesia.
8	English2, Chinese Simplified, Chinese Traditional.

Note: Tegic- T9 Input method support in for the languages BOLD.

TABLE 2.2 SOFTWARE LANGUAGE GROUPS.

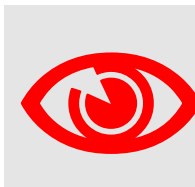

***This information is subject to change!
Contact your Service Manager for the order number of the right version of mobile software for your market.***

The mobile software file is named using this convention:



e.g. C3i_0501 → Version = 05; Language Group = 1
C3i_0506 → Version = 05; Language Group = 6.

This executable file needs a definition or init file, named **SWUP.INI**, to define the message language preferences and the hardware communication port set up.
 The content of this file consists of the following text:

```
Language=English
COM=x
```

Where x is the number that corresponds to the serial port that is used, either 1, 2 or 3.

Flow chart 2.1 illustrates the software programming process.

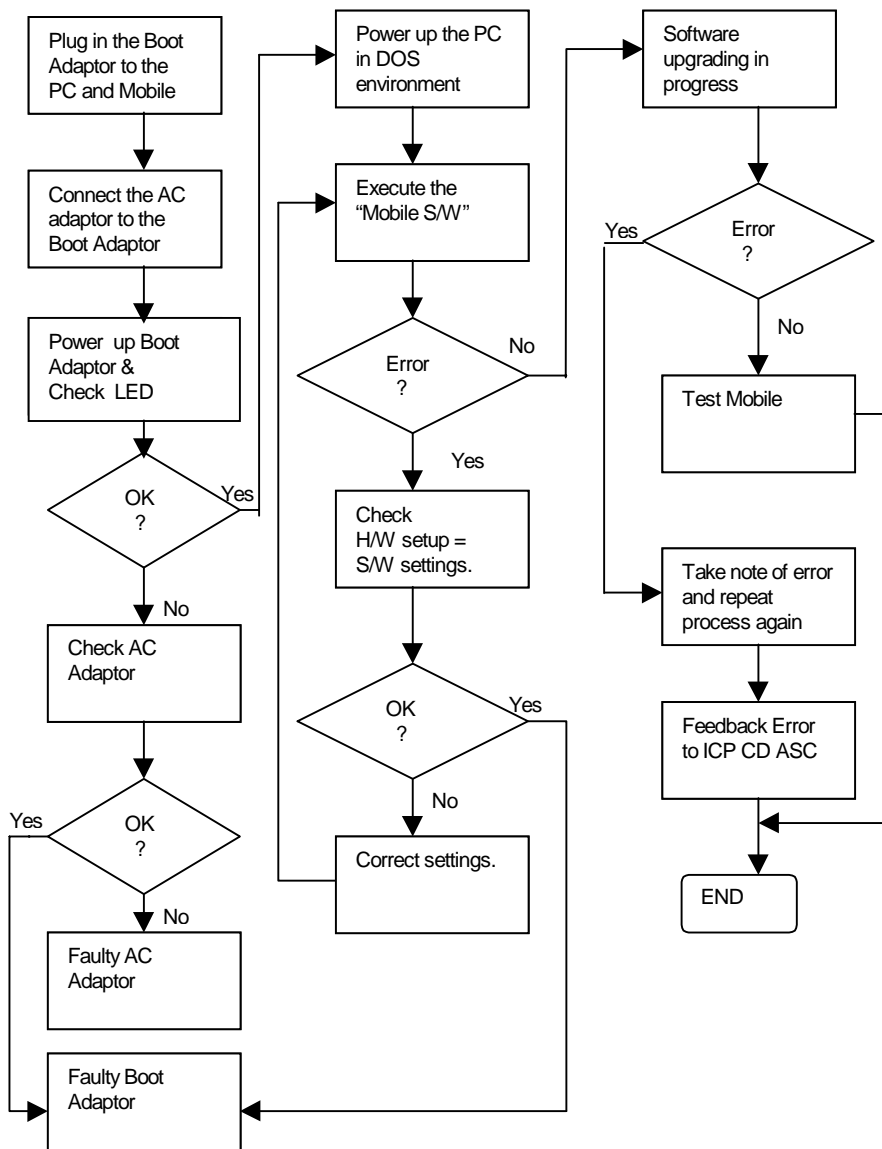

FLOWCHART 2.1 SOFTWARE PROGRAMMING. PROCESS

Customer Specific Initialization

Refer to the Customization Guide

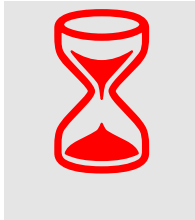

LSO has to make sure that after repair the customer gets the mobile with correct variant specific initialization.

For more information about the configuration tool, refer to Service Information dated 30th April 1999, or contact your Service Manager.

International Mobile Equipment Identity, IMEI

The mobile equipment is uniquely identified by the International Mobile Equipment Identity, IMEI, which consists of 15 digits. Type approval granted to a type of mobile is allocated 6 digits. The final assembly code is used to identify the final assembly plant and is assigned with 2 digits. 6 digits have been allocated for the equipment serial number for manufacturer and the last digit is spare.

C35 series IMEI label is accessible by removing the battery. It is illustrated in Photo 2.18.



PHOTO 2.18 C35 SERIES IMEI LABEL

Re-use of IMEI label is possible by using a hair-dryer to remove the IMEI label.

On this IMEI label, Siemens has also includes the date code for production or service, which conforms to the industrial standard DIN EN 60062. The date code comprises of 2 characters: first character denotes the Year and the second character denotes the Month. For example, the IMEI above show date code **M1**.

Year	Date Code	Month	Date Code
1999	L	December	D
2000	M	January	1
2001	N	February	2

TABLE 2.3 DIN EN 60062 DATE CODE

Phone Unblocking

When the phone is disabled due to wrong entry of PHONECODE, it can be re-activated by entering the right unblocking code. This unblocking code is derived from the IMEI number of the mobile.

The unblocked code, also known as Master Phone Code, has to be entered in the following format:

*** # 0 0 0 3 * - - - - - #**

The Master Phone Code can be obtained by:

1. Fax to Siemens Hotline in Germany

Siemens AG
ICP CD SH
World Service Center, Bocholt, Germany
+49-2871-91-3007

2. Fax to Siemens Hotline in Singapore

Siemens Advanced Engineering Pte Ltd
ICP CD ASC
Ms Ginny Siew
+65-842-6641

3. Internet Solution

A password protected homepage where LSO can enter IMEI number of a disabled phone. The generated Master Code will then be presented for unblocking purpose. This service is offered to all LSOs.



PHOTO 2.19 INTERNET PAGE



PHOTO 2.20 INTERNET PAGE: MASTER PHONE CODE



Contact your Service Manager for more information regarding setting up of the INTERNET SOLUTION & its installation procedure, ASC/T002/98.

Siemens Service Equipment

USER MANUAL

Introduction

Every LSO repairing Siemens handset must ensure that the quality standards are observed. Siemens has developed an automatic testing system that will perform all necessary measurements. This testing system is known as

Siemens Mobile Service Equipment

Using this system vastly simplifies the repair of the phones and will make sure that:

1. All possible faults are detected
2. Set which pass the test will be good enough to return to customer.

Starting from the P35 Series, Siemens will introduce a simpler and faster testing platform for testing a repaired Siemens mobile phone. The testing platform are either base on R&S CMD 53/55 or CTS55 GSM test set.

There is also test software under development for testing with the Wavetek 4201S and the 4107 GSM test set.

A Level 2.5 service software is also under development for more elaborate testing for the repair for the P35 series mobile phone.



THE LSO WILL HAVE TO PURCHASE THE SYSTEM, CHOOSING BETWEEN THE COMPLETE PACKAGE OR SUB-SET OF IT.

A FULLY AUTOMATIC TEST PROCEDURE IS ONLY POSSIBLE IF THE COMPLETE SYSTEM IS INSTALLED.



Make sure that your CTS firmware is Version 3.01 or higher. For CMD 55 it must be Version 4.03 and higher. Please check with the Service Info SB_0500 for the CTS/CMD Hardware Options.

R&S CMD55 Test Station

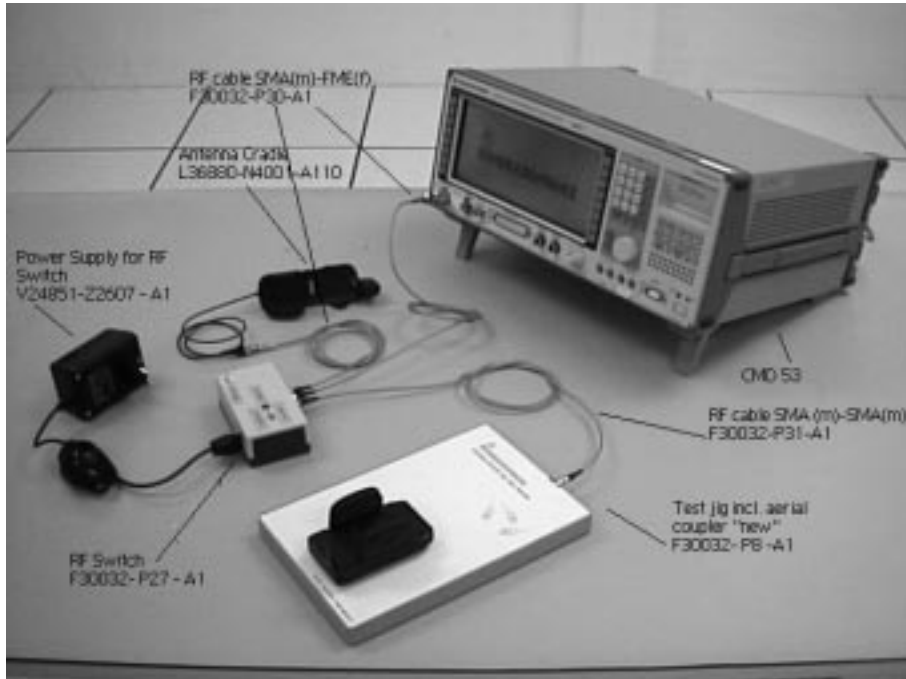

R&S CTS55 Test Station

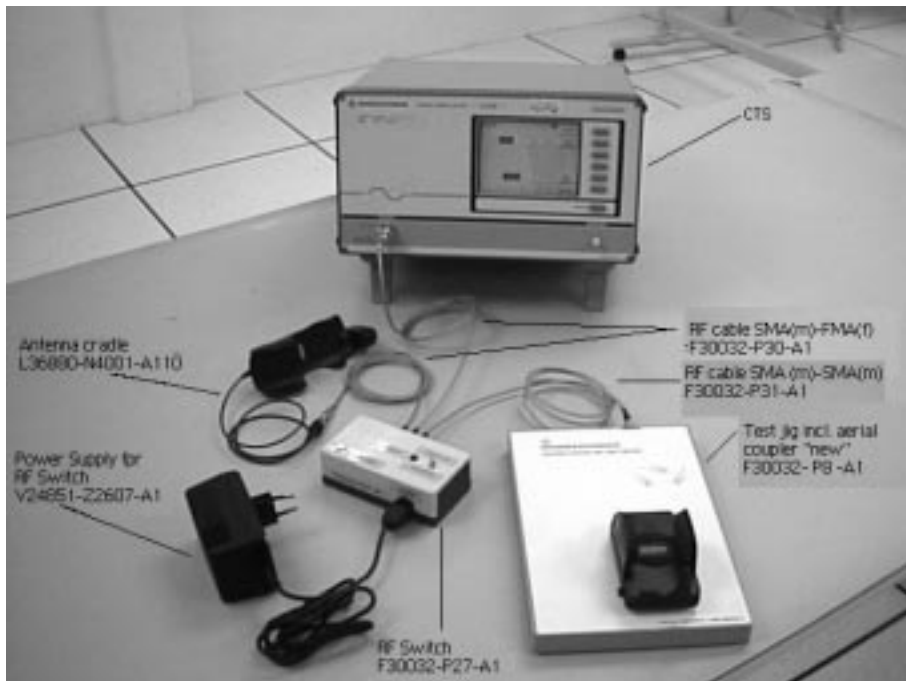

Wavetek 4201S Test Station

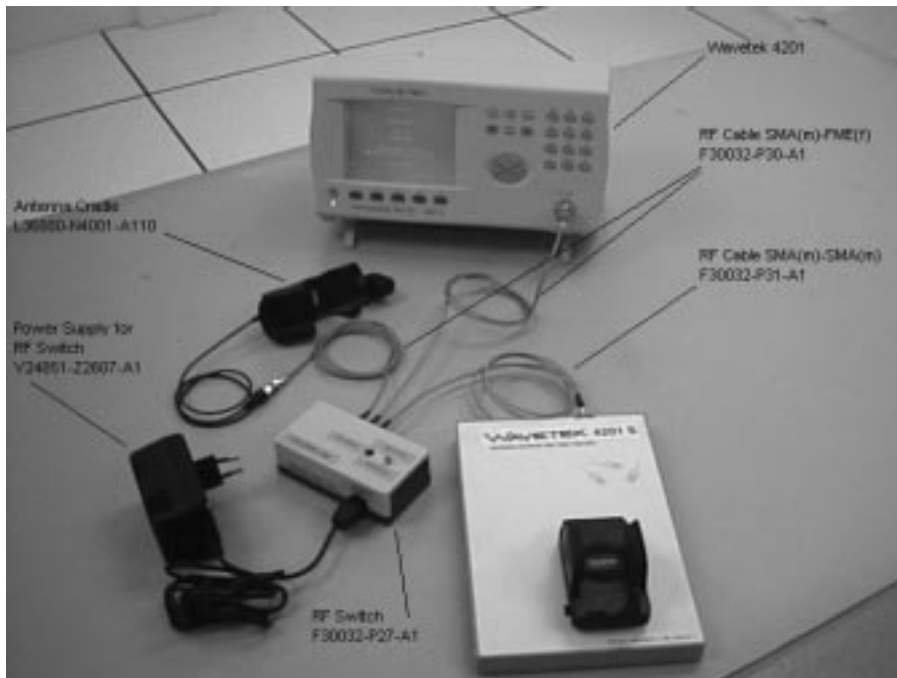

Other equipment

One Pentium MMX Window 95/98 PC with a serial port to connect to the GSM test set through the PC serial cable provided for the GSM test set.

One Test SIM card and a fully charged battery for used with the mobile phone model.

Additional RF connector will be needed for setup using Wavetek 4107 test set and Wavetek Antenna Coupler.

For LSO Test Station setup base on the Wavetek 4107 test set, you need a TNC(male) to SMA(female) connector. For the Wavetek Antenna Coupler, you need a TNC(female) to SMA(female) connector. The part number for the connectors will be announced soon.



For Wavetek GSM test set



For Wavetek Antenna Coupler

Software Installation

Before executing the test software, it is important to ensure that the software configuration matches that of the hardware set up. Each GSM Tester will have a specific test software. The test software are name CMD_GO, CTS_GO and for Wavetek test set, CAT4200 respectively.

First, copy the installation software for the specific GSM tester to a temporary directory on the harddisk of the Window PC and then Run the Setup from the first sub directory – Disk1 for CMD_GO test software.

After the installation for the test software, RUN the Test software and check the configuration setting for the Serial port.

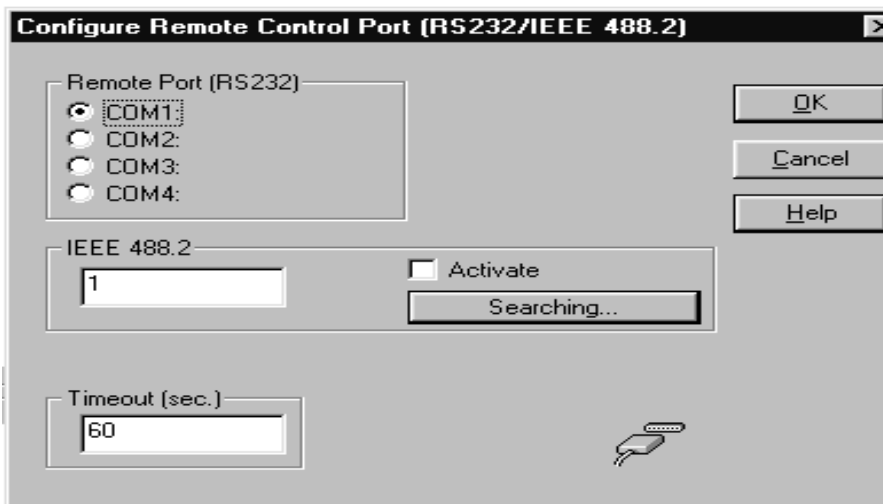
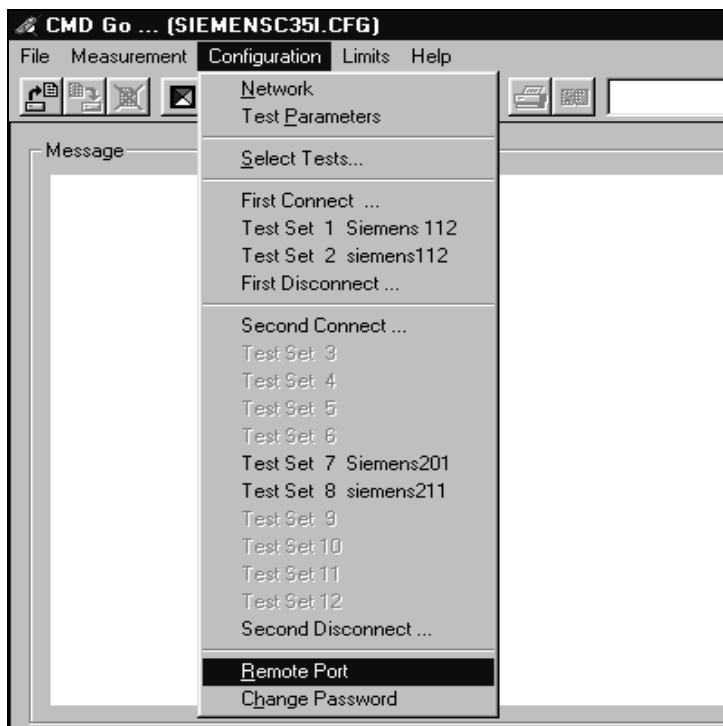

Configuring the test software

For each model of the P35 series mobile phone, Siemens will distribute the testing configuration file for the specific test station. For testing the phone, just go to the File menu and select Load Configuration.

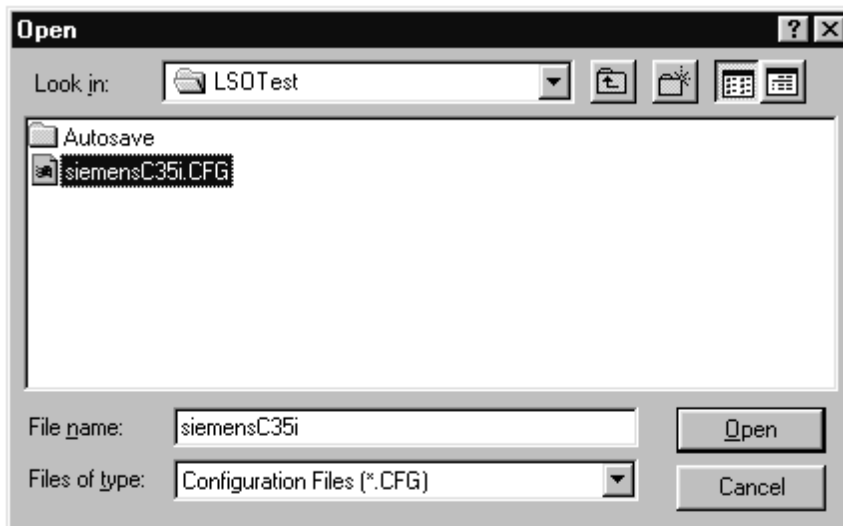
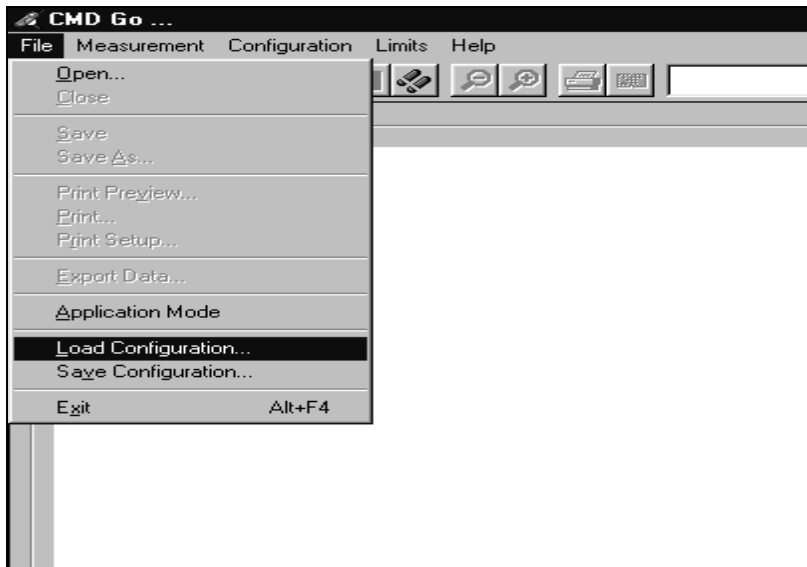

Running the test sequence



Make sure that your CTS firmware is Version 3.01 or higher. For CMD 55 it must be Version 4.03 and higher. Please check with the Service Info SB_0500 for the CTS/CMD Hardware Options.

Insert a Test SIM card and a fully charged battery into the Siemens mobile phone and place it onto the phone holder on the Antenna Coupler. Switch the RF switch to INT ANT position and select the Start button to run the test sequence in the configuration file.

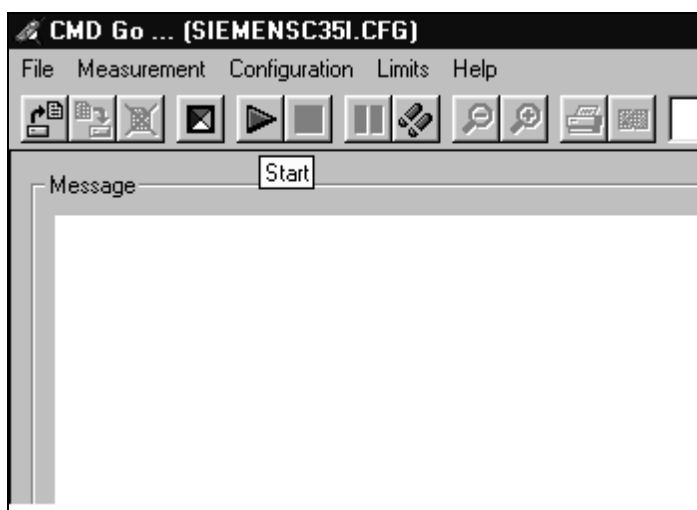

Follow the instruction on the screen and switch on the phone. The mobile phone will start Network Search and doing Location Update to the GSM test set through the off-air signal from Antenna Coupler.

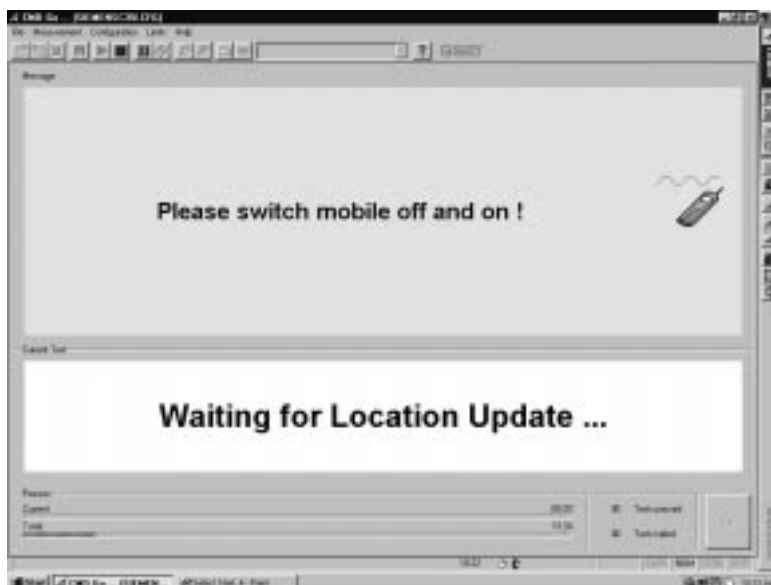

Next, the GSM test set will initial a call to the mobile phone through the Antenna Coupler. Press the Call key when the mobile phone ring, and the GSM test set will start Tx Power measurements on the GSM and GSM1800 channel specified by the configuration setting.

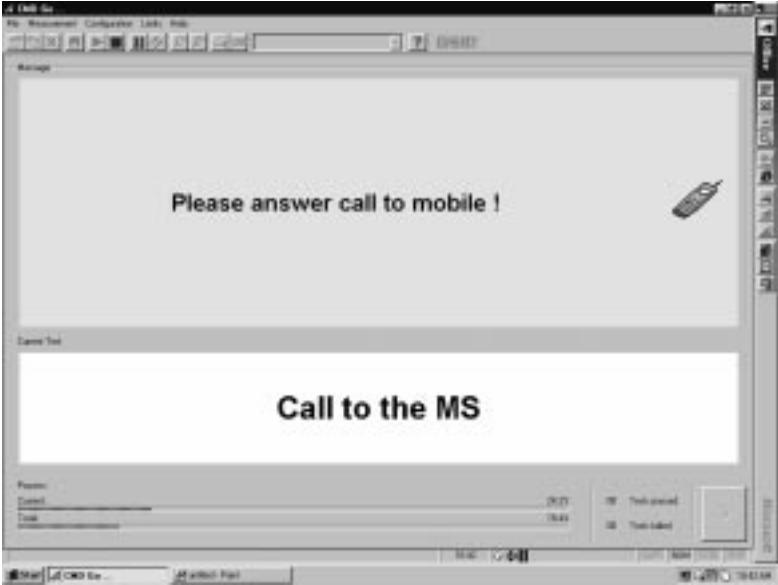

Next, the GSM test set will end the call to the mobile phone and the screen will prompt for Dialing from the mobile phone. At this test step, please move the mobile phone to the Antenna Cradle and switch the RF switch to EXT ANT position. Once the mobile phone log to the GSM test set, dial 1234 and the Send key.

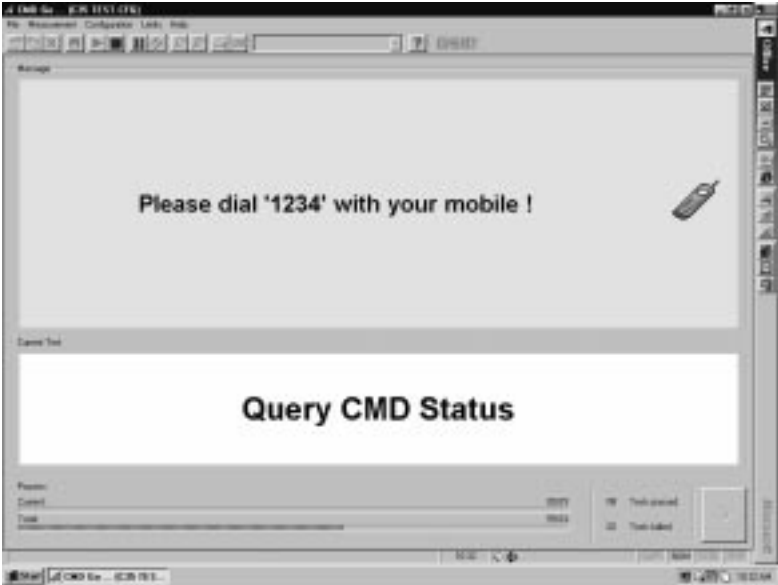

The GSM test set will make Tx Power measurements, Rx BER measurement, Echo Loop test on the GSM and GSM1800 channel specified by the configuration setting. There will be 2 Echo Loop Back test for checking the speech quality – one for GSM and one for GSM1800. Speak into the mobile phone when prompted and listen the voice after appr. 1 second and check the speech quality. If not O.K, it may be microphone or the earphone defective.



The last test is Disconnect Call from the mobile phone. Press the End Call key and the test sequence will end.

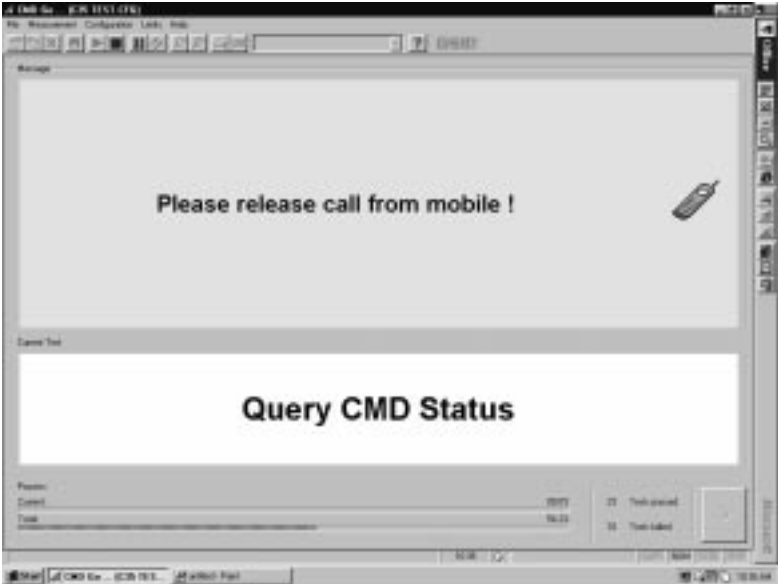

A measurement report screen will show up and a hardcopy can be printed if a printer is connected to the PC. To close the measurement report screen, click the third button from the left.

Measurement Report **ROHDE & SCHWARZ**

Operator: noname 11:27:47 AM 4/2/00

BS Parameters: RF Attenuation In/Out: 0.0 dB/0.0 dB, BCCW: 1, BS Power at Loc. Upd.: -70.0 dBm

Signalisation Parameters: WSP: 262.00, 1234567890, AMS: 449191, 61, 057210, Power Class: 4, Revision Level: 0

Test Configuration: CMD Issue: 946644016, V 4.01 26.11.99D, Configuration: C35 TEST.GPS

Test Condition:	Lower Limit	Upper Limit	Measured Value	PTF
Testset: 1 (TCW: 124, Power Control Level: 6, Timing Advance: 0, RF Attenuation In/Out: 10.0 dB/10.0 dB)				
Frequency Error (at BS Power -57.0 dBm, 10 Bauds)	-90.00 Hz	90.00 Hz	-30.00 Hz	✓
Phase Error RMS		5.00 °	1.00 °	✓
Phase Error Peak	-20.00 °	20.00 °	-5.25 °	✓
Timing Error	-2.00 Bits	2.00 Bits	not performed	
Average Power MS (at BS Power -51.0 dBm)	31.00 dBm	35.00 dBm	33.30 dBm	✓
Power Time Template			passed	✓
Testset: 2 (TCW: 7, Power Control Level: 6, Timing Advance: 0, RF Attenuation In/Out: 16.0 dB/16.0 dB)				
Frequency Error (at BS Power -65.0 dBm, 10 Bauds)	-90.00 Hz	90.00 Hz	-30.00 Hz	✓
Phase Error RMS		5.00 °	1.74 °	✓
Phase Error Peak	-20.00 °	20.00 °	4.66 °	✓
Timing Error	-2.00 Bits	2.00 Bits	not performed	
Average Power MS (at BS Power -65.0 dBm)	31.00 dBm	35.00 dBm	34.10 dBm	✓
Power Time Template			passed	✓
Dialled Number (2, Content)			1234	✓
Testset: 3 (TCW: 1, Power Control Level: 15, Timing Advance: 0, RF Attenuation In/Out: 3.0 dB/3.0 dB)				
Frequency Error (at BS Power -70.0 dBm, 10 Bauds)	-90.00 Hz	90.00 Hz	-22.00 Hz	✓
Phase Error RMS		5.00 °	1.66 °	✓
Phase Error Peak	-20.00 °	20.00 °	4.26 °	✓

Once the mobile phone pass all the test steps, please make a check for all the key and the display. After this we can confirm on the proper functioning of the mobile phone after repair and return the phone back to the customer.

ANNEX A

Cable Specifications

1. PC to NGSM(Power Supply)

Depending on the type of serial connector that is used by the PC. The cable layout for both 9pins and 25pin are listed below:

Computer: Sub-D 25 pins	NGSM: Sub-D 25 pins
TxD Pin 2	RxD Pin 3
RxD Pin 3	TxD Pin 2
RTS Pin 4	DCD Pin 8
DCD Pin 8	RTS Pin 4
CTS Pin 5	DTR Pin 20
DSR Pin 6	DTR Pin 20
DTR Pin 20	CTS Pin 5
DTR Pin 20	DSR Pin 6
GND Pin 7	GND Pin 7

TABLE A.1 D25 TO D25 CONNECTION

Computer: Sub-D 9 pins	NGSM: Sub-D 25 pins
TxD Pin 2	RxD Pin 3
RxD Pin 3	TxD Pin 2
RTS Pin 7	DCD Pin 8
DCD Pin 1	RTS Pin 4
CTS Pin 8	DTR Pin 20
DSR Pin 6	DTR Pin 20
DTR Pin 4	CTS Pin 5
DTR Pin 4	DSR Pin 6
GND Pin 5	GND Pin 7

TABLE A.2 D9 TO D25 CONNECTION

2. PC to CMD 53 or CTS 55

Depending on the type of connector used for the PC serial interface, two different type of cables can be used:

Computer: Sub-D 25 pins	CMD / CTS: Sub-D 9 pins
TxD Pin 2	RxD Pin 2
RxD Pin 3	TxD Pin 3
DSR Pin 6	DTR Pin 4
GND Pin 7	GND Pin 5
DTR Pin 20	DSR Pin 6
CTS Pin 5	RTS Pin 7
RTS Pin 4	CTS Pin 8

TABLE A.3 D25 TO D9 CONNECTION

Computer: Sub-D 9 pins	CMD / CTS: Sub-D 9 pins
RxD Pin 3	TxD Pin 2
TxD Pin 2	RxD Pin 3
DSR Pin 6	DTR Pin 4
GND Pin 5	GND Pin 5
DTR Pin 4	DSR Pin 6
CTS Pin 8	RTS Pin 7
RTS Pin 7	CTS Pin 8

TABLE A.4 D9 TO D9 CONNECTION

3. PC to Adaptor Box

Computer: Sub-D 9 pins	Adaptorbox: Sub-D 9 pins
TxD Pin 2	RxD Pin 3
RxD Pin 3	TxD Pin 2
DTR Pin 4	DSR Pin 6
GND Pin 5	GND Pin 5
DSR Pin 6	DTR Pin 4
RTS Pin 7	CTS Pin 8
CTS Pin 8	RTS Pin 7

TABLE A.5 D9 TO D9 CONNECTION

Jumper Settings of NGSM(Power Supply)

Internal dip switches of the power supply, NGSM 32/10, must be set correctly to ensure proper communication between PC and the NGSM. These switches are set up by Siemens and tested before delivery, hence it is not necessary to change it normally.

These switches are located under the left side of the cover of the NGSM.

Position	OFF	ON	OFF	OFF	ON	OFF	OFF	ON
----------	-----	----	-----	-----	----	-----	-----	----



Switch No.	1	2	3	4	5	6	7	8
------------	---	---	---	---	---	---	---	---

TABLE A.6 SWITCH SETTINGS

Test SIM card Information

For testing purposes, in combination with the Rohde & Schwarz GSM tester, CMD or CTS, it is mandatory to use the enclosed test SIM card.

If you do not use this test SIM card, you will encounter difficulties in getting correct measurement for the Bit Error Rate.



When the SIM card simulation is set to '1' in the INI file, then this test SIM card is not needed at all

There are two different PIN numbers stored in the SIM card. The PINs and their respective Master-PIN are:

PIN 1	12 34
Master-PIN 1	76 54 32 10
PIN 2	56 78
Master-PIN 2	98 76 54 32

TABLE A.7 D25 TO D25 CONNECTION

ANNEX B

Service Equipment List

All purchases of jigs, tools and test equipment must be order directly from Siemens Germany. Attach the standard form with your purchase order and send it to ICP CD SL and ICP CD ST.

Pos. No.	Name	Siemens Partnumber	Order? (☒=Yes)
Special testequipment for use with CMD 53			
1	GSM Tester CMD 53 incl. Options B1, B4, B30	F30032-P1-A1	<input type="checkbox"/>
11	RF-Switch	F30032-P27-A1	<input type="checkbox"/>
12	Powersupply for RF-Switch	V24851-Z2607-A1	<input type="checkbox"/>
13	RF-cable SMA(m) ↔ FME(f)	F30032-P30-A1	<input type="checkbox"/>
14	RF-cable SMA(m) ↔ SMA(m)	F30032-P31-A1	<input type="checkbox"/>
15	RF-cable SMA(m) ↔ SMA(f)	F30032-P32-A1	<input type="checkbox"/>
Special testequipment for use with CTS 55			
10	GSM-Tester CTS 55 incl. Options B1, B7, K6, K9, K18	F30032-P24-A1	<input type="checkbox"/>
11	RF-Switch	F30032-P27-A1	<input type="checkbox"/>
12	Powersupply for RF-Switch	V24851-Z2607-A1	<input type="checkbox"/>
13	RF-cable SMA(m) ↔ FME(f)	F30032-P30-A1	<input type="checkbox"/>
14	RF-cable SMA(m) ↔ SMA(m)	F30032-P31-A1	<input type="checkbox"/>
15	RF-cable SMA(m) ↔ SMA(f)	F30032-P32-A1	<input type="checkbox"/>
Testequipment for use with CTS 55 or CMD 53			
16	Test-SIM-Card (plug-in type)	F30032-P2-A1	<input type="checkbox"/>
17	RS 232 cable PC ↔ CMD / CTS (9pins.)	F30032-P3-A1	<input type="checkbox"/>
21	Printer incl. parallel cable	F30032-P7-A1	<input type="checkbox"/>
22	Test jig incl. aerial coupler "new"	F30032-P8-A1	<input type="checkbox"/>
23	Connector N ↔ FME(m)	F30032-P11-A1	<input type="checkbox"/>
24	User manual test software CMD / CTS	F30032-P13-A1	<input type="checkbox"/>
25	Disk with test software CMD / CTS	F30032-P19-A1	<input type="checkbox"/>
	Antenna Cradle C35/S35/M35	L36880-N4001-A110	<input type="checkbox"/>
	For use with C25/ C35 SW Upgrade Station		
26	Boot Adapter incl. AC-Adapter, serial cable & Mobile connection cable. Need nos 41 for C35.	L24857-F1006-A30	<input type="checkbox"/>
43	Adapter-Cable-Bootadapter C25/C35	V30146-A5004-D	<input type="checkbox"/>
Opening -Tools for use with C25/C35			
44	Case opener C35	F30032-P46-A1	<input type="checkbox"/>
Battery Analyser			
45	CADEX Tester C7000	F30032-P49-A1	<input type="checkbox"/>
46	Universal Adapter	F30032-P59-A1	<input type="checkbox"/>



TABLE B.1 SERVICE EQUIPMENT ORDER FORM

For detail information, contact your Service Manager

Level 2.5 Repair Document

Introduction

The C/M/S35 product family consists of 5 different dualband handsets (GSM-900 and GSM-1800), which can easily be distinguished from the second block of the part number printed on the IMEI label. There also exist Asian variants of C/M/S35 named 3508 / 3518 / 3568 respectively. All information below also applies to the Asian variants unless otherwise noted.

Partnumber on IMEI label:

- 1) C35 / 3508: S30880-**S4000**-Xxxx
- 2) C35i / 3508i: S30880-**S4050**-Xxxx
Same as C35 / 3508 but with additional WAP and fax/data capabilities
- 3) M35 / 3518: S30880-**S4200**-Xxxx
- 4) M35i / 3518i: S30880-**S4250**-Xxxx
Same as M35 / 3518 but with additional WAP and fax/data capabilities
- 5) S35i / 3568i: S30880-**S4100**-Xxxx

This manual is intended to help you carry out repairs on level 2.5, meaning limited component repairs. Failure highlights are documented and should be repaired in the local workshops.

It must be noted that all repairs have to be carried out in an environment set up according to the ESD (Electrostatic Discharge Sensitive Devices) regulations defined in international standards.



All repairs have to be carried out in an environment set up according to ESD regulations defined in international standards.

ESD procedure is available from your Service Manager. Ask for ASC/T001/98

Fault code listed must be used for LSO reporting purpose.

Fault Description	Fault Code	Part Number

If you have any questions regarding the repair procedures or spare parts do not hesitate to contact our technical support team in Kamp-Lintfort, Germany:

Tel.: +49 2842 95 4666

Fax: +49 2842 95 4302

e-mail: dominik.schnoor@klf.siemens.de

This manual is intended to help you carry out repair on Level 2.5, i.e. limited component repair. Failure highlighted in this document should be repaired in the local workshop.

Antenna Connector

Affected Units

Type: C/M/S35
Affected IMEIs / Date Codes: All / All
Affected SW-Versions: All
Fault Code for LSO reporting: 3ANC

Fault Description

Fault Symptoms for customers:

Network Search when using the external antenna (carkit)
No location update possible on external antenna (carkit)

Fault Symptom on GSM-Tester:

Output power problems on the external antenna
No location update possible

Component Information

The Antenna Connector is a mechanical switch operated by the RF plug of a carkit or, for testing purposes, of an RF clip. Normally the RF signal goes to and comes from the internal antenna. Whenever an RF plug is plugged into the antenna connector the connection to the internal antenna is opened and the connection to the external antenna socket is made. See drawing below.

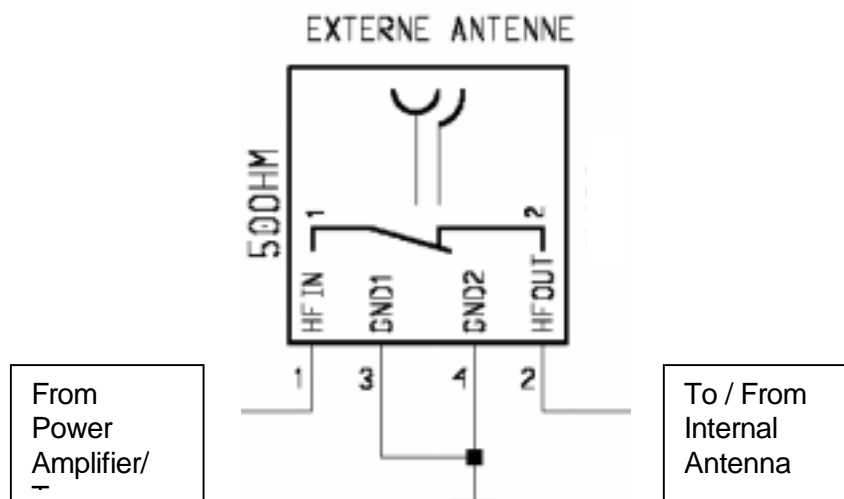

Priority:

- Mandatory
- Repair
- Optional
- Not Yet Defined

Repair Documentation**Description of procedure:****DIAGNOSIS**

Check the output power of the handset with the LSO testprogram.
Especially watch the external antenna power!

REPAIR BY COMPONENT CHANGE

Use hot air blower to remove defective connector
Avoid excessive heat!
Watch surrounding components!

Resolder new connector afterwards.

REPAIR BY SW-BOOTING

Not possible!

TEST

Retest handset after repair as described above.

List of needed material**COMPONENTS**

X35 antenna connector
Attention: This is not the same connector as C25/S25 !!!

Part-Number: L36334-Z93-C272

JIGS AND TOOLS

Hot Air Blower
Soldering Iron

SPECIAL TOOLS

None

WORKING MATERIALS

Desolder Wick / Braid
Solder

Drawings

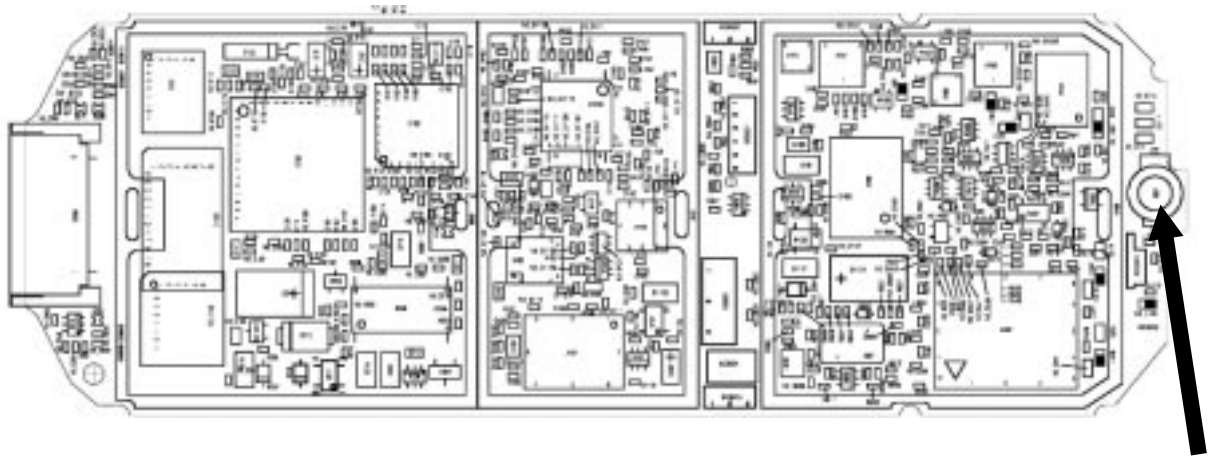

Figure 1: X35 Board Antenna Connector Side (Top View)

Ringer

Affected Units

Type: C/M/S35
Affected IMEIs / Date Codes: All / All
Affected SW-Versions: All
Fault Code for LSO reporting: 3RIN

Fault Description

Fault Symptoms for customers:

Problems with the handset ringer. No ringer tone audible.

Fault Symptom on GSM-Tester:

Handset fails ringer test.

Priority:

- Mandatory
- Repair
- Optional
- Not Yet Defined

Repair Documentation

Description of procedure:

DIAGNOSIS

Visually check the ringer. Watch for physical damage or dry joints.

REPAIR BY COMPONENT CHANGE

Resolder dry soldering joints.

If the ringer is physically damaged use hot air blower or wick to remove defective connector.

Avoid excessive heat!

Watch surrounding components!

Resolder new ringer afterwards.

REPAIR BY SW-BOOTING

Not possible!

TEST

Retest handset after repair.

List of needed material

COMPONENTS

Ringer P35:

Part-Number: L36178-Z2-C26

JIGS AND TOOLS

Hot Air Blower
Soldering Iron

SPECIAL TOOLS

None

WORKING MATERIALS

Desolder Wick / Braid
Solder
Flux

Drawings

Figure 1: X35 Board Ringer Side

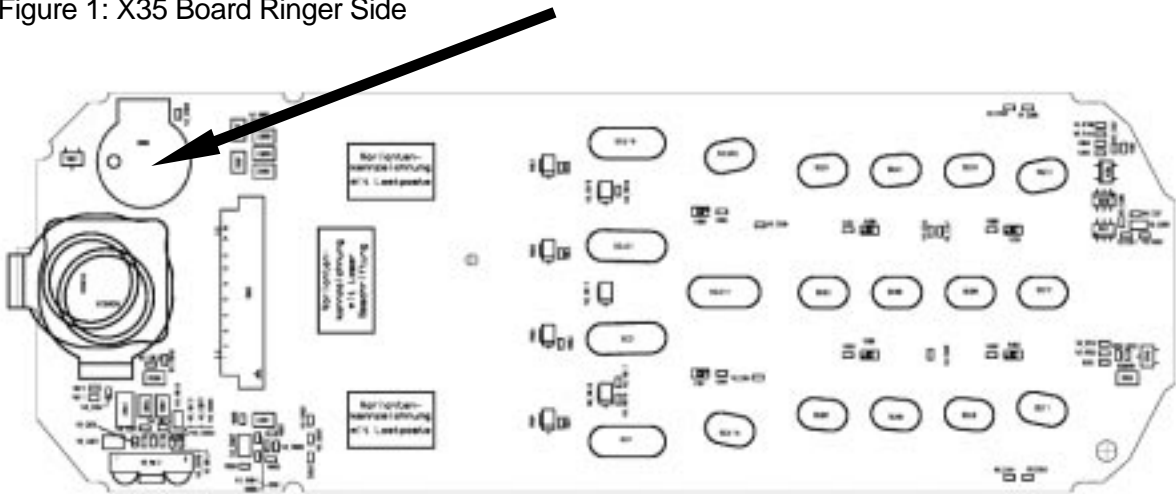
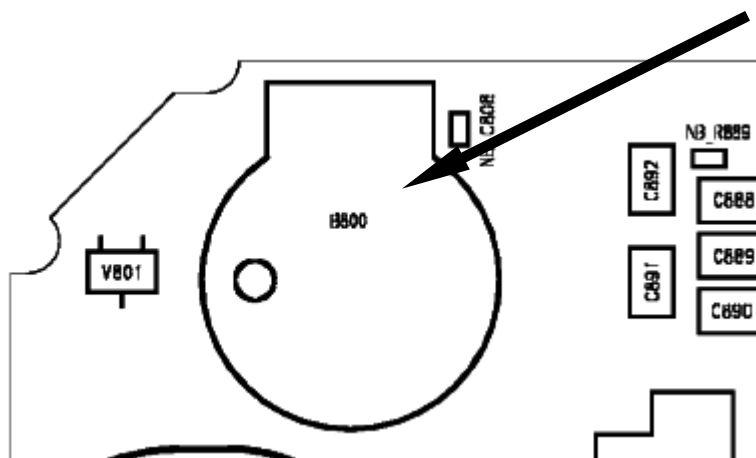

Figure 2: X35 Ringer (B800) Placement (Top View)



Bottom Connector (Lumberg)

Affected Units

Type:	C/M/S35
Affected IMEIs / Date Codes:	All / All
Affected SW-Versions:	All
Fault Code for LSO reporting:	3LUC

Fault Description

Fault Symptoms for customers:

Charging problems.
Problems with external loudspeaker or microphone when using a car kit.
Problems with accessories connected at the bottom connector.
Problems with SW booting.

Fault Symptom on GSM-Tester:

This problem cannot be detected with a GSM-Tester.

Priority:

- Mandatory
- Repair
- Optional
- Not Yet Defined

Repair Documentation

Description of procedure:

DIAGNOSIS

Visually check the bottom connector. Watch for dry joints!

REPAIR BY COMPONENT CHANGE

Use hot air blower remove defective bottom connector.
Avoid excessive heat!
Watch surrounding components!

Resolder new bottom connector afterwards.

REPAIR BY SW-BOOTING

Not possible!

TEST

Retest handset after repair.

List of needed material:

COMPONENTS

Bottom Connector X35
Part-Number: L36334-Z93-C262

JIGS AND TOOLS

Hot Air Blower
Soldering Iron

SPECIAL TOOLS

None

WORKING MATERIALS

Desolder Wick / Braid
Solder

Drawings

Figure 1: X35 Board Bottom Connector Side

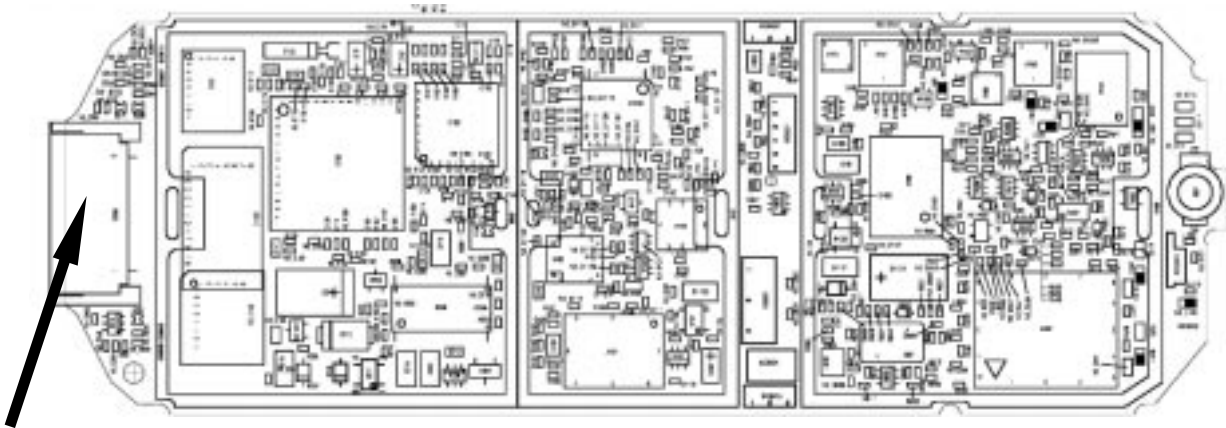

Figure 2: X35 Bottom Connector Placement (Top View)

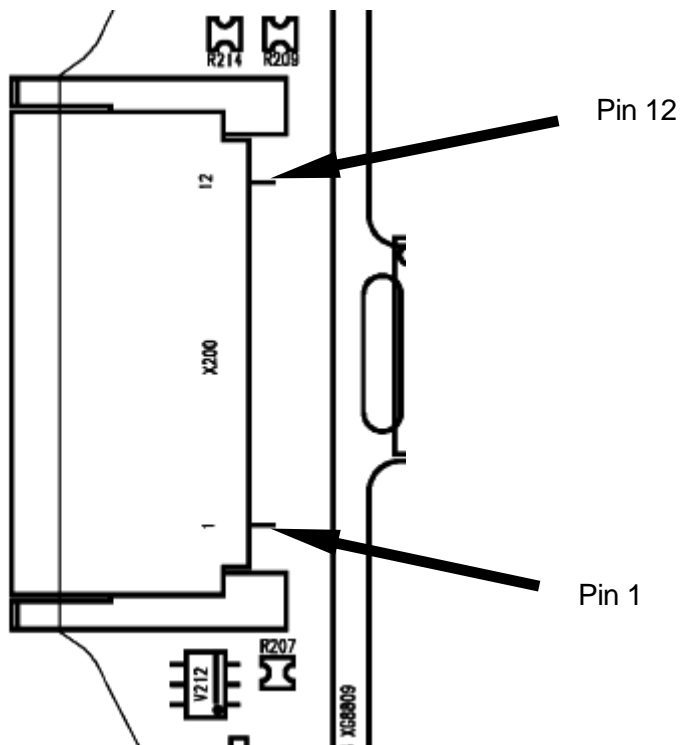

Table 1: X35 Bottom Connector Pin Description

Pin	Name	IN/OUT	Notes
1	GND		
2	SB	I/O	Charger coding and charger control.
3	POWER	I	Charging Current
4	FBatt+	O	Power supply for the accessories.
5	TX	O	Serial interface
6	RX	I	Serial interface
7	ZUB_CLK	I/O	Clock line for accessory bus Use as DTC In data operation
8	ZUB_DATA	I/O	Data line for accessory bus. Use as CTS in data operation
9	GND_MIC		For external microphone
10	HF_MIC	I	External microphone
11	AUDO	O	Trigger for external loudspeaker
12	GNDA		For external loudspeaker

Display Connector

Affected Units

Type: C/M/S 35

Affected IMEIs / Date Codes: *All / All*

Affected SW-Versions: *All*

Fault Code for LSO reporting: **3DIC**

Fault Description

Fault Symptoms for customers:

Display problems, like missing lines or columns on the LCD or display contrast problems.

Fault Symptom on GSM-Tester:

Display test fails.

Priority:

- Mandatory
- Repair
- Optional
- Not Yet Defined

Repair Documentation

Description of procedure:

DIAGNOSIS

Visually check the status of the display connector. Watch for oxidation and dry solder joints.
Mechanically check the opening / closing mechanism.

REPAIR BY COMPONENT CHANGE

Use hot air to remove defective connector
Avoid excessive heat!
Watch surrounding components!!

Resolder new connector afterwards

REPAIR BY SW-BOOTING

Not possible!

TEST

Retest handset after repair.

List of needed material

COMPONENTS DISPLAY CONNECTOR

Part-Number: L36195-Z26-C629

JIGS AND TOOLS

Soldering Iron
Hot Air Blower

SPECIAL TOOLS

None

WORKING MATERIALS

Desolder Wick / Braid
Solder

Drawings

Figure 1: X35 board display connector side

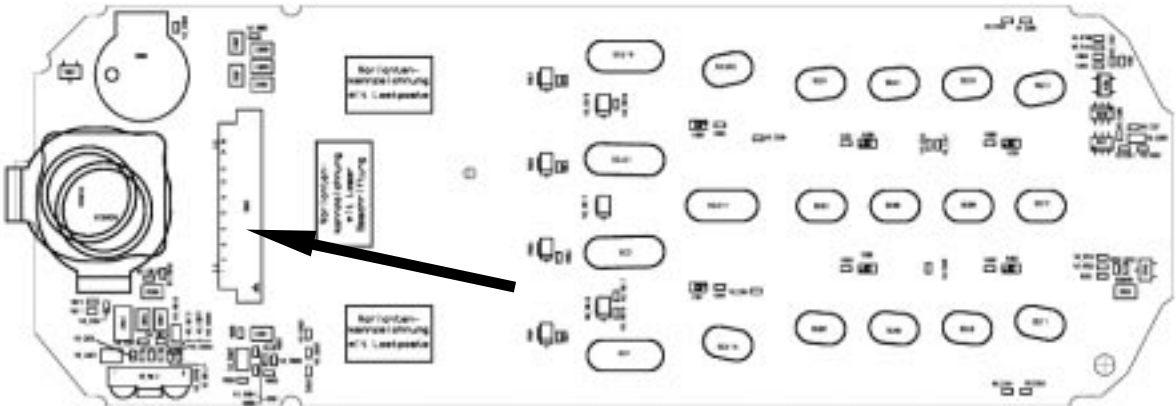

Figure 2: X35 display connector placement (Top View)



Keyboard LEDs

Affected Units

Type: C/M/S 35

Affected IMEIs / Date Codes: *All / All*

Affected SW-Versions: *All*

Fault Code for LSO reporting: 3LED

Fault Description

Fault Symptoms for customers:

Keyboard Illumination not working.

Fault Symptom on GSM-Tester:

This fault cannot be detected with a GSM-Tester

Priority:

- Mandatory
- Repair
- Optional
- Not Yet Defined

Repair Documentation

Description of procedure:

DIAGNOSIS

Use the diode test function of a multimeter to check the status of the diode.

The typical voltage drop on the diode is 1.7V when testing the diode function with the multimeter.

REPAIR BY COMPONENT CHANGE

Use soldering iron to remove defective diode
Avoid excessive heat!
Watch surrounding components!

Resolder new diode afterwards.

REPAIR BY SW-BOOTING

Not possible!

TEST

Retest handset after repair.

List of needed material

COMPONENTS

LED keyboard X35
Part-Number: L36840-L2031-D670

JIGS AND TOOLS

Hot Air Blower
Soldering Iron

SPECIAL TOOLS

None

WORKING MATERIALS

Desolder Wick / Braid
Solder

Drawings

Figure 1: X35 board keyboard LED Side

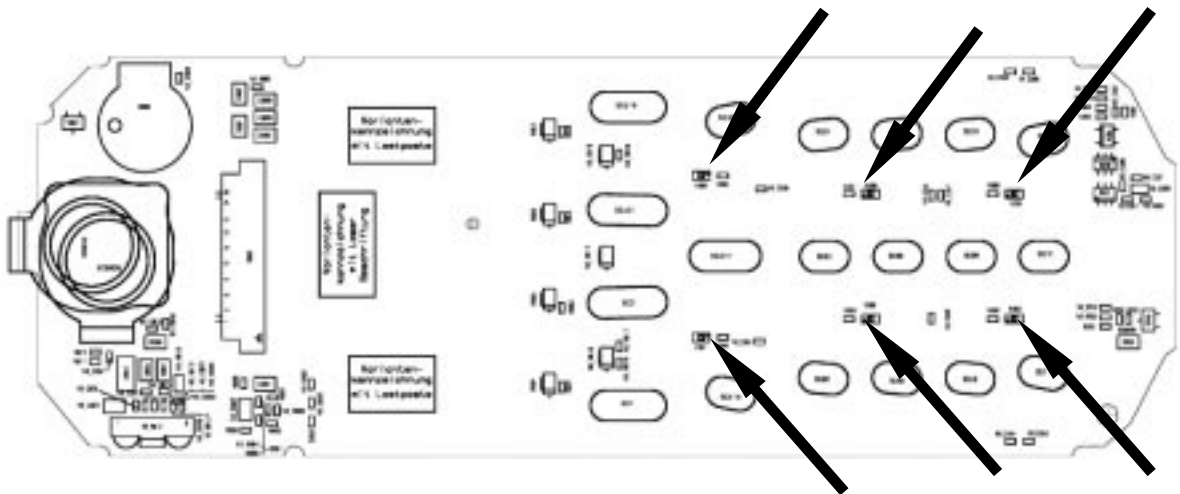
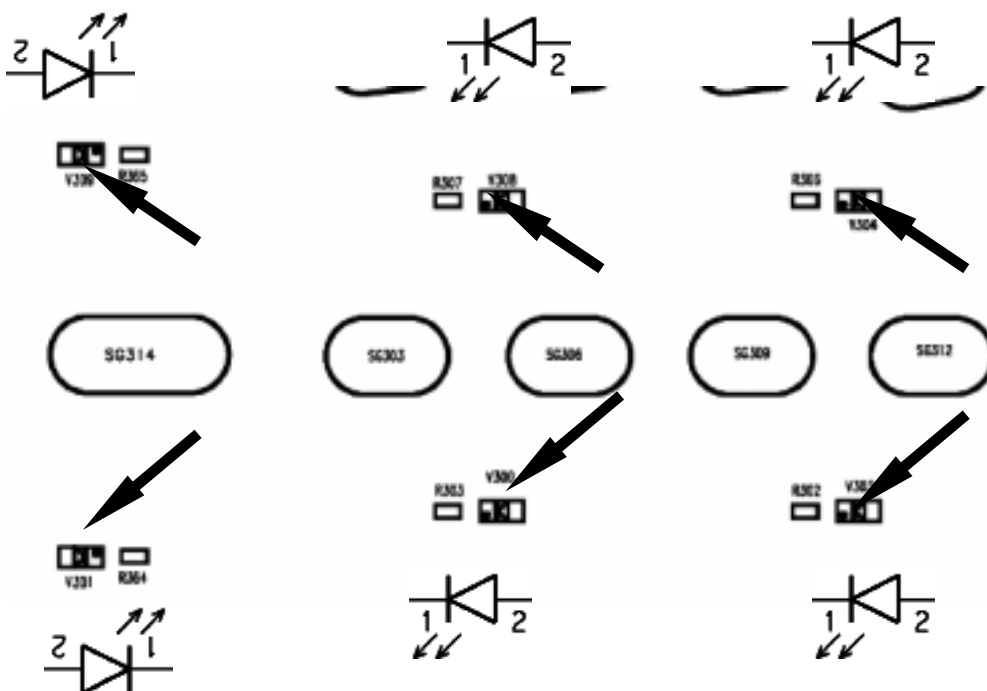

Figure 2: X35 keyboard LED placement and polarity (top view)



Display LEDs

Affected Units

Type: C/M/S 35

Affected IMEIs / Date Codes: *All / All*

Affected SW-Versions: *All*

Fault Code for LSO reporting: 3LED

Fault Description

Fault Symptoms for customers:

Display Illumination not working.

Fault Symptom on GSM-Tester:

This fault cannot be detected with a GSM-Tester

Priority:

- Mandatory
- Repair
- Optional
- Not Yet Defined

Repair Documentation

Description of procedure:

DIAGNOSIS

Use the diode test function of a multimeter to check the status of the diode.

The typical voltage drop on the diode is 1.7V when testing the diode function with the multimeter.

Attention: There are two different types of display LEDs, one for C/M35 and one for S35! Also they use different placement location, see drawings 1 and 3.

REPAIR BY COMPONENT CHANGE

Use soldering iron to remove defective diode
Avoid excessive heat!
Watch surrounding components!

Resolder new diode afterwards.

REPAIR BY SW-BOOTING

Not possible!

TEST

Retest handset after repair.

List of needed material

COMPONENTS

Display LED S35
Part-Number: L36840-**L2048**-D670

Display LED C/M35
Part-Number: L36840-**L2047**-D670

JIGS AND TOOLS

Hot Air Blower
Soldering Iron

SPECIAL TOOLS

None

WORKING MATERIALS

Desolder Wick / Braid
Solder

Drawings

Figure 1: C/M35 board display LED Side

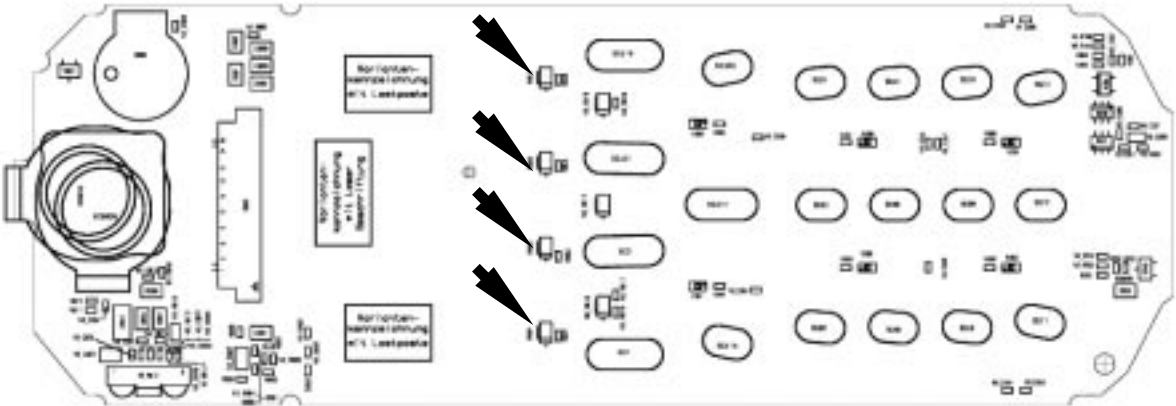

Figure 2: C/M35 board display LED placement and polarity

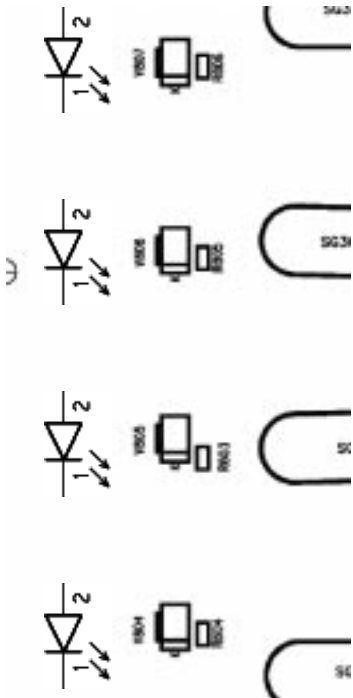

Figure 3: S35 board display LED side

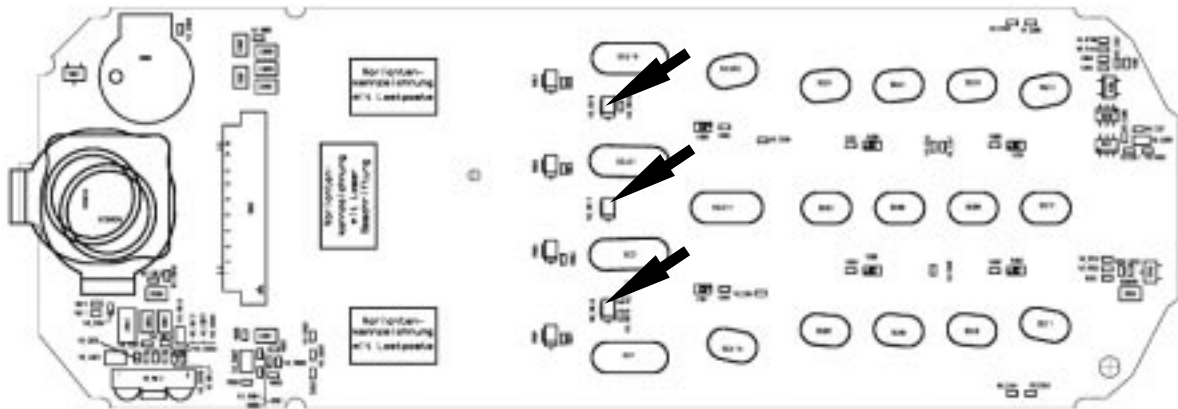
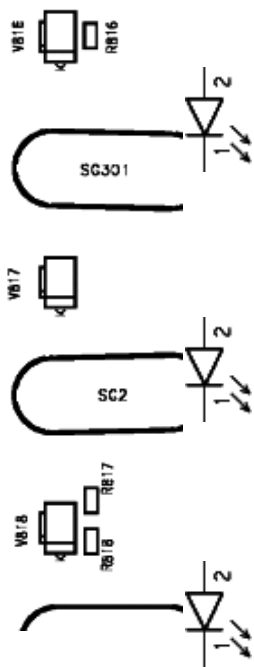

Figure 4: S25 board display LED placement and polarity



Infrared Diodes

Affected Units

Type: S 35
Affected IMEIs / Date Codes: *All / All*
Affected SW-Versions: *All*
Fault Code for LSO reporting: 3INF

Fault Description

Fault Symptoms for customers:

No infrared connection possible.

Fault Symptom on GSM-Tester:

This fault cannot be detected with a GSM-Tester.

Priority:

- Mandatory
- Repair
- Optional
- Not Yet Defined

Repair Documentation

Description of procedure:

DIAGNOSIS

Visually check the status of the IrDa module. Watch for dry solder joints. Use a reference infrared port (eg. from a notebook) to check the IrDa function. If the notebook recognizes the S35, the infrared function is ok.

REPAIR BY COMPONENT CHANGE

Use hot air to remove defective infrared module.
Avoid excessive heat!
Watch surrounding components!!

Resolder new module afterwards

REPAIR BY SW-BOOTING

Not possible!

TEST

Retest handset after repair.

List of needed material

COMPONENTS INFRARED MODULE S35

Part-Number: L36810-U6030-D670

JIGS AND TOOLS

Soldering Iron
Hot Air Blower

SPECIAL TOOLS

None

WORKING MATERIALS

Desolder Wick / Braid
Solder

ANNEX C

PC Adaptor Cable & Accessories C35

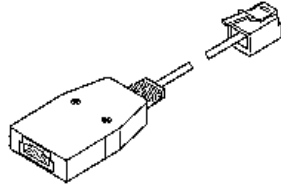

Adapter Cable E-Box-PC
L36880-N3101-A112

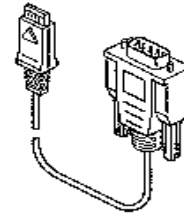

Adapter Cable PC-Mobilephone
L36880-N3101-A102

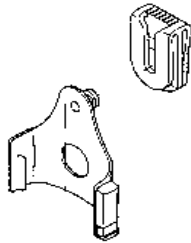

Belt Clip
L36880-N4001-A113

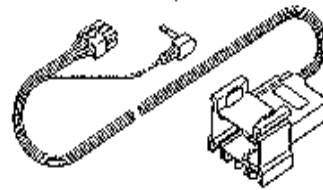

VDA Adaptercable
L36880-N4001-A121

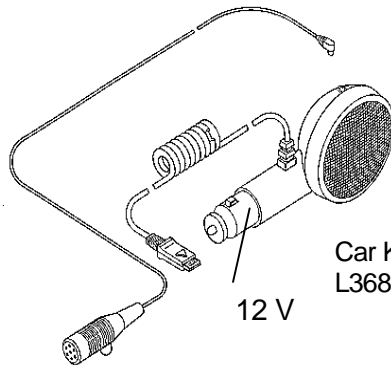

Car Kit Portable Handsfree Set
L36880-N3015-A117

12 V

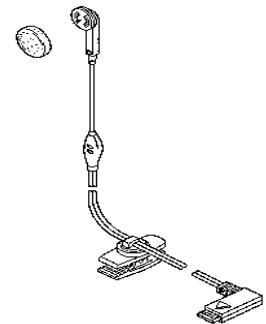

Headset
L36880-N4001-A123

Car Kit Portable Handsfree Microphone
L36254-Z6-C75

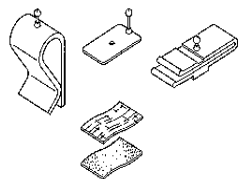

Microphone Accessories Kit
L36158-A98-C6

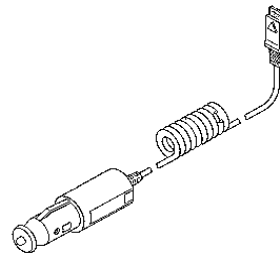

Car Charger Cable 10,8-24V
L36880-N4001-A108



Car Holder
L36158-A24-C25

Power Plug for C35, M35, S35

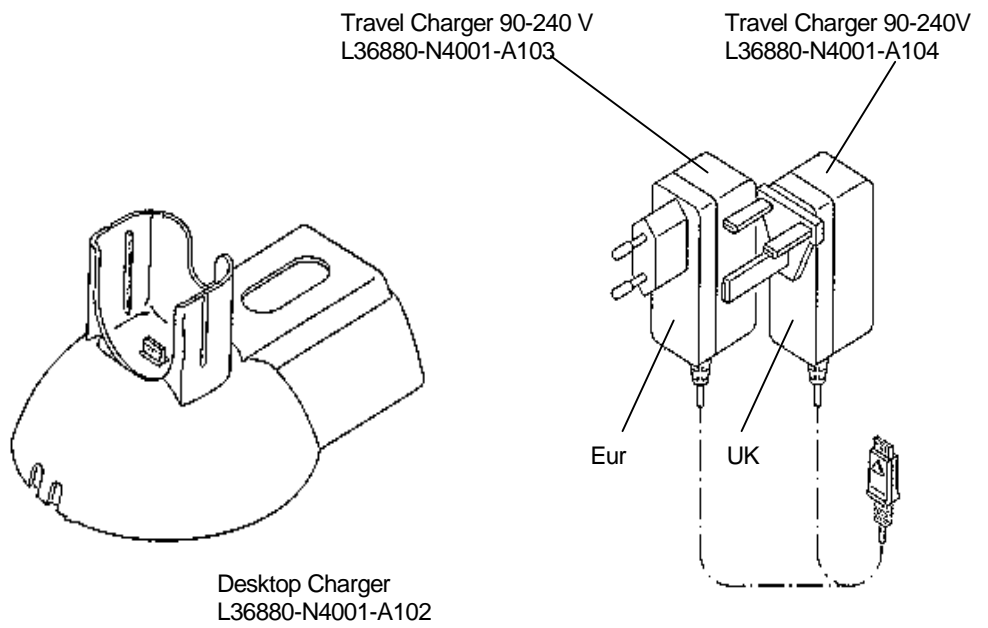
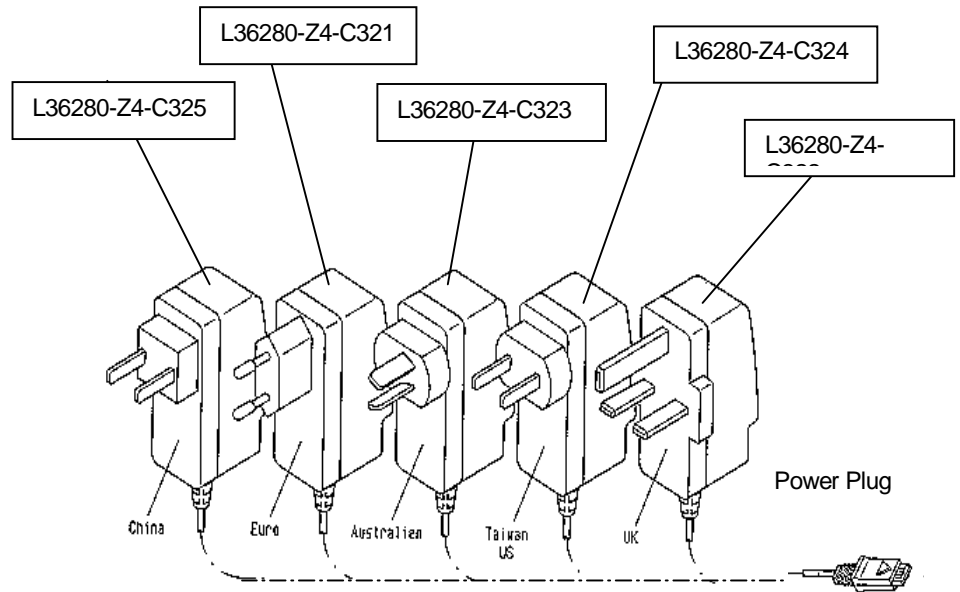

Car installation kit Ratio unit C35, M35 & S35

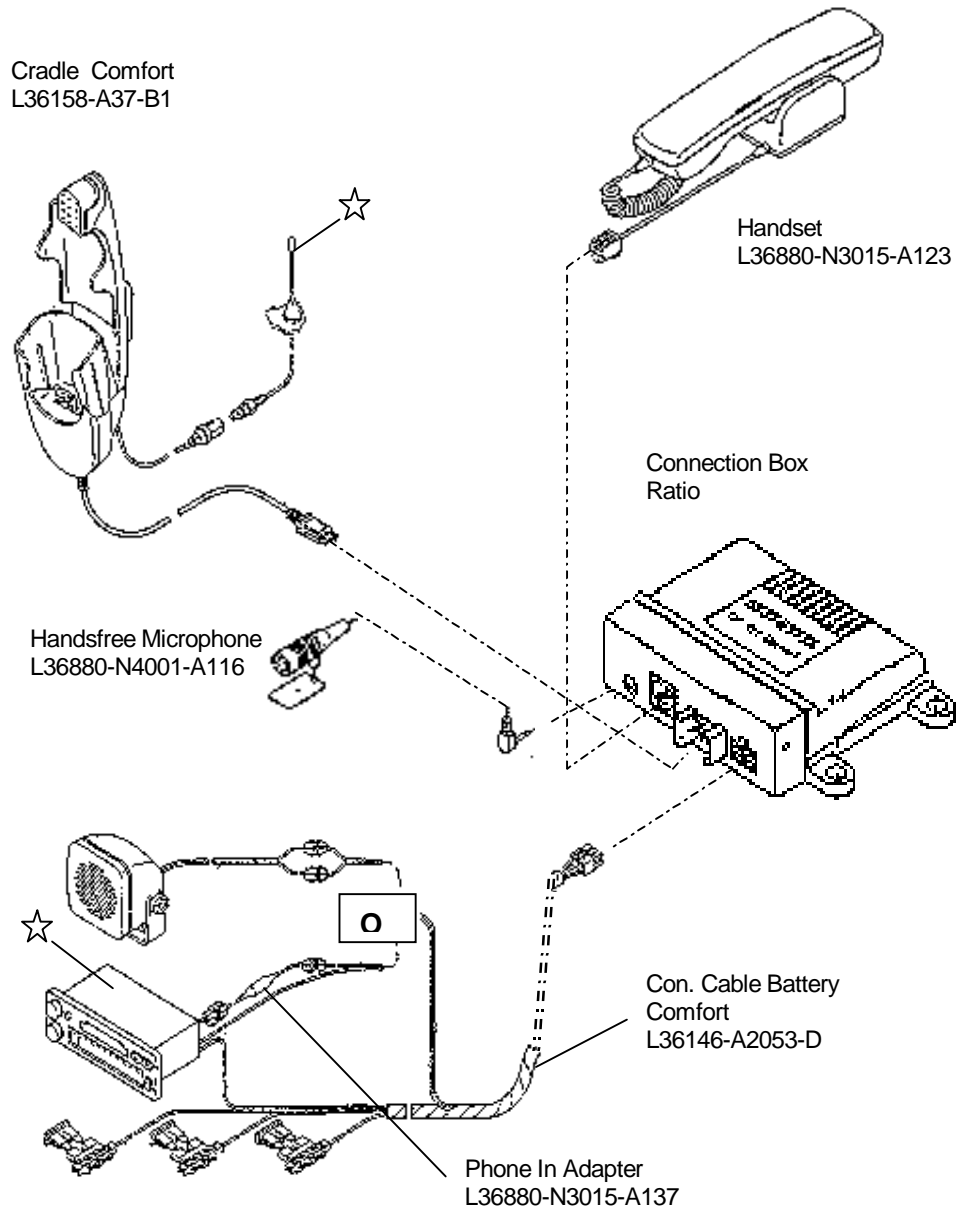

☆ **Not included in our Standard Delivery**

Car installation kit hands free unit C35, M35, S35

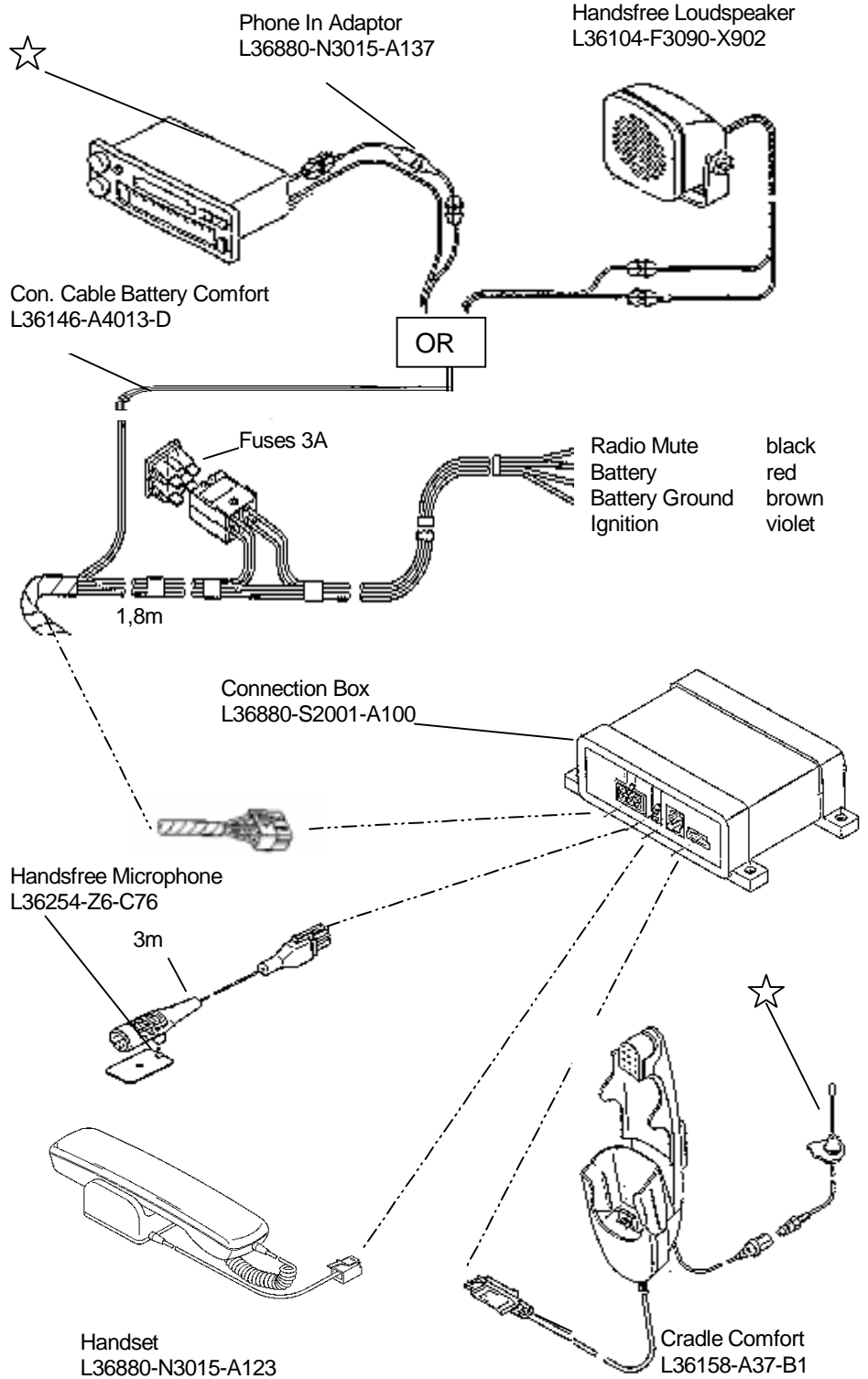

★ **Not included in our Standard Delivery Program**

Carkit installation kit hand free unit Professional C35, M35, S35

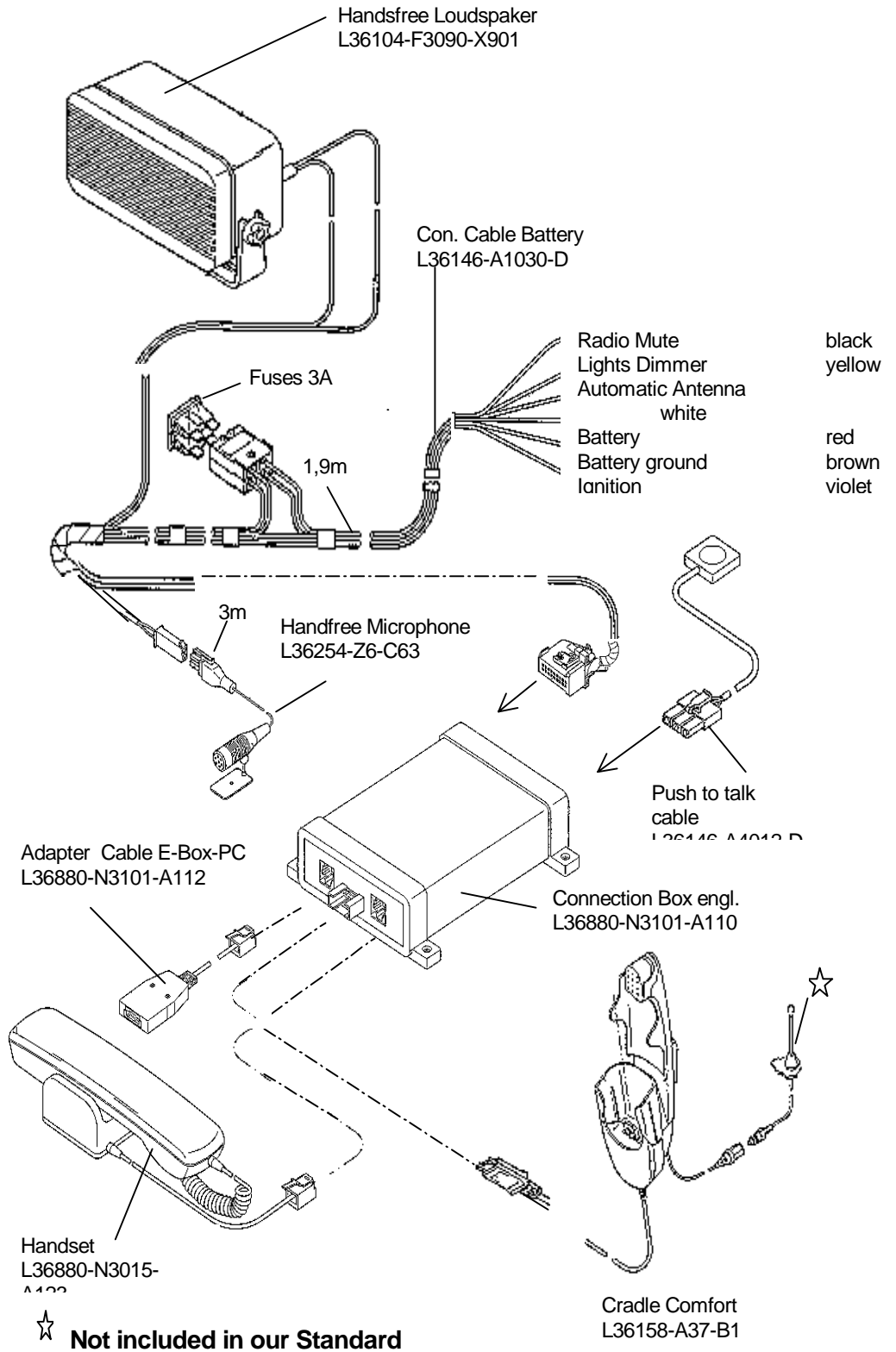

Carkit installation Comfort GPS C35, M35, S35

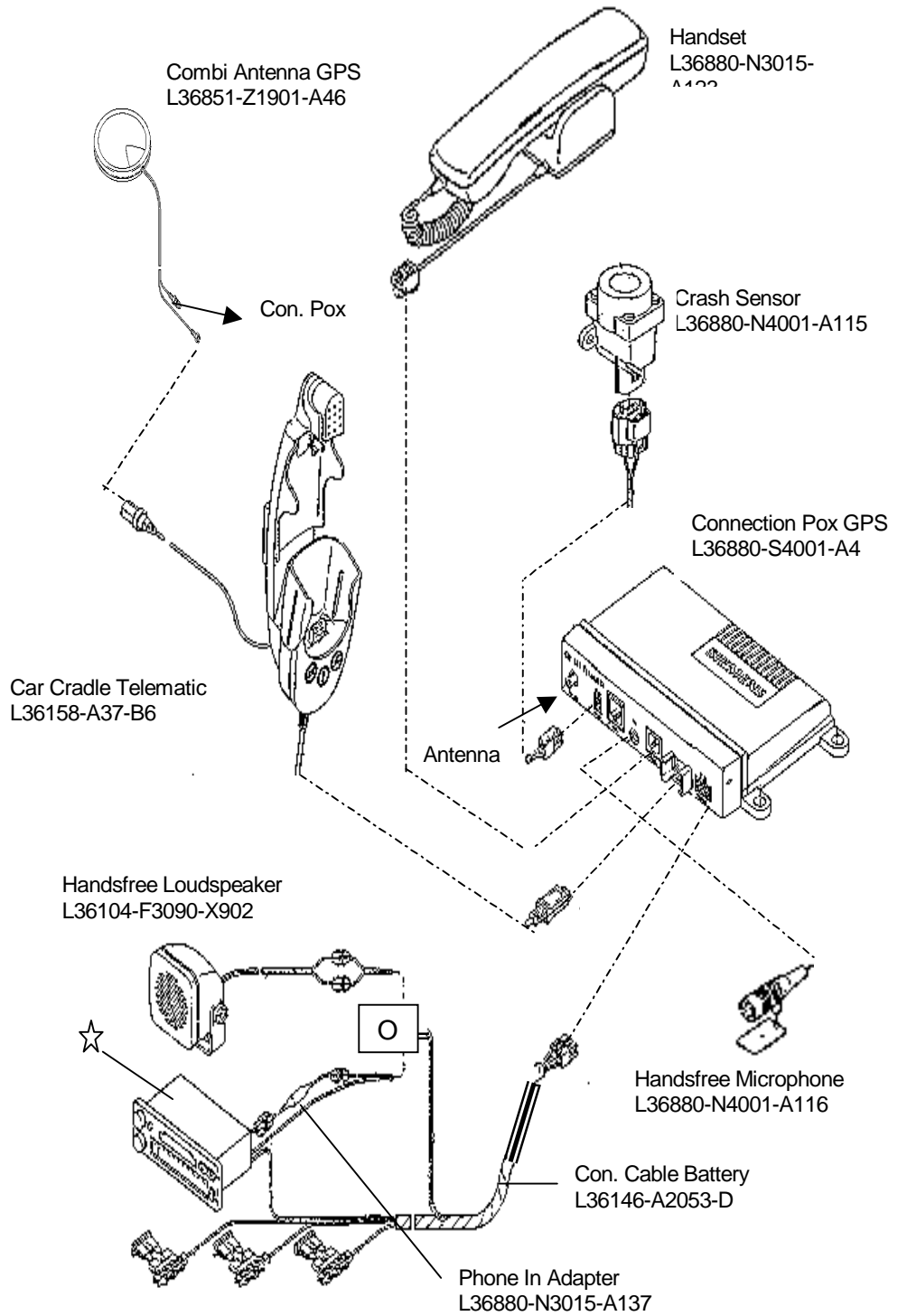

☆ **Not included in our Standard**

PC Adaptor Cable & Accessory C35, M35, S35

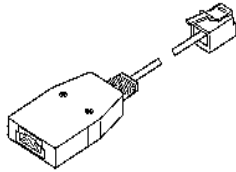

Adaptor Cable E-Box -PC
L36880-N3101-A112

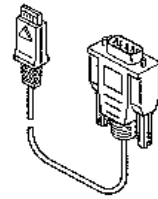

Adapter Cable PC-Mobilephone
L36880-N3101-A102

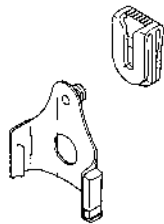

Clip
L36880-N4001-A113

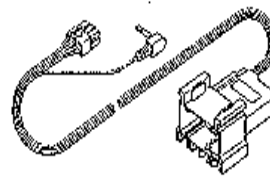

VDA Adaptercable
L36880-N4001-A121

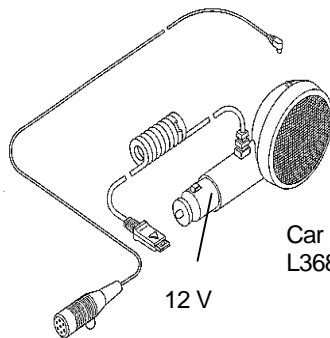

Car Kit Portable Handsfree Set
L36880-N3015-A117

Car Kit Portable Handsfree Microphone
L36254-Z6-C75

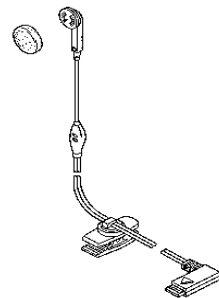

Headset
L36880-N4001-A123

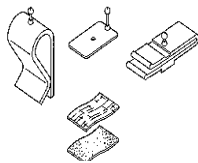

Microphone Accessories Kit
L36158-A98-C6

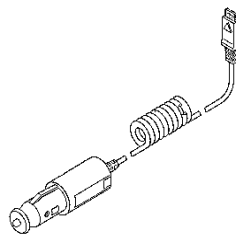

Car Charger cable 10, 8 – 24V
L36880-N4001-A108



Car Holder
L36158-A24-C25

References:

1. Mouly M. & Pautet M-B. (1992) *The GSM System for Mobile Communications, A comprehensive overview of the European Digital Cellular Systems* France: Published by authors.
2. Scourias, J *Overview of the Global System for Mobile Communications* University of Waterloo: Published by author.
3. - (1998) *GSM Introduction* Published by Wavetek Wireless Communication Division.
4. Barnes, N *SIM Application Toolkit*, Article by author on ETSI Website.
5. Mehrotra A, (1994), *Cellular Radio Analog and Digital System*, Artech House Inc, USA.
6. IrDA(Infrared Data Association), *Serial Infrared Physical Layer Link Specification, Version 1.1*, October 15, 1995.

Disclaimer: This content is subjected to change without notice.

Copyright © 2000 Siemens Advanced Engineering Pte Ltd
ICP CD Asia Service Center,
164, Kallang Way, #04-22, Kolam Ayer Industrial Estate, Singapore 349248
Author: Tan Guan San.
Phone +65-8454822 • Fax +65-8426641
First Print: April, 00
Revised Print:

The reproduction and transmission of this document to unauthorized parties is not permitted without written authority. Offender will be liable for damages.